

TEN REASONS TO BUY DAIKIN



Airconditioning Specialist
Daikin focuses on airconditioning solutions and control systems. As specialists, it's all we do. No wonder, Daikin is recognised as an expert in airconditioning.



Unmatched After Sales Support
Daikin takes pride in providing its customers with efficient after sales support, including readily available spare parts warehoused in India.



Pioneer in Air Conditioners
Daikin has been providing airconditioning solutions for over 12 years in India. As one of the industry's more trusted names, Daikin airconditioning equipment can be found in homes, offices, hotels and shops. Daikin is committed to the airconditioning market and has a manufacturing facility located in Rajasthan.



3 year warranty on compressors
Reliability. That's probably top of your list when buying an airconditioning system for your home or business. Daikin gives you peace of mind and reassurance with their 3-year warranty* on compressors. That's how confident Daikin is about the quality and reliability of its product.



The Daikin Edge with In-house Manufacturing
Daikin is the only company in the world dedicated to manufacturing both airconditioning systems and refrigerants. Each element has been designed to work flawlessly with the next - delivering optimal performance - from the time a project begins till the moment of absolute comfort.



Wise Investment-Low Running Cost
When you buy a Daikin airconditioning system you need to look beyond the initial purchase price. It pays to consider ongoing running costs in conjunction with the potential life of the product. Daikin systems offer superior build quality and energy efficiency.



High Energy Efficiency
Daikin's continuous drive for improved efficiency has seen its advance inverter technology being applied to split, ducted and other systems. These systems provide a more comfortable environment and are more energy efficient when compared to non-inverter systems.



Experienced Dealers
Daikin distributes its products through experienced dealers. This ensures that you receive a top quality product with expert support. Together this means the best airconditioning solution for your individual needs.



Comprehensive Range and quiet operation
Daikin has a comprehensive range of products in both domestic and commercial segments. Designed to provide effective and quiet airconditioning, Daikin can customise a solution to meet every requirement.



Environment Friendly
Daikin continues to work towards a sustainable future and has received Environmental Management System certification to ISO 14001. Daikin India is dedicated to preserving and protecting the environment through the production of energy efficient products.

DAIKIN AIRCONDITIONING INDIA PVT. LTD.

12th Floor, Building No. 9, Tower A, DLF Cyber City, DLF Phase III, Gurgaon - 122 002, Haryana, India.
Tel.: 0124-4555444, Fax.: 0124-4555333. Corporate Identification Number (CIN) - U74899DL2000PTC104990
Registered Office: F-25/2, Okhla Industrial Area, Phase II, New Delhi - 110 020, e-mail: ho@daikinindia.com

SALES & SERVICE OFFICES

Ahmedabad: 079-26583013/14, 36583364
Bengaluru: 080-25590452-54
Chandigarh: 0172-5089862-64
Chennai: 044-24314210-15
Delhi-NCR: 011-26385924-27
Hyderabad: 040-39134289/93

Jaipur: 0141-2223215, 2225569
Kolkata: 033-22894259/60
Lucknow: 0522-2787307/340/291
Mumbai: 022-30926666
Pune: 020-25560300

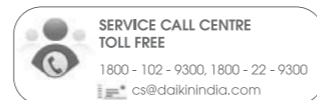

Visit us at www.daikinindia.com

Follow us on: www.facebook.com/daikinindia www.twitter.com/daikinindia www.daikinindiablog.com

As a continuing policy of product innovation at Daikin, the design and specifications are subject to change without prior notice. The visuals of the products in the catalogue are representative only, actual products might differ from the ones shown. Sales revenue includes revenue through sales of all Daikin Airconditioning Systems.

World's no.1 position based on internal assessment of total company sales revenue for 2012/13.
*Product mentioned in this catalogue comply with RoHS regulations as per E-waste (Management & Handling) Rules, 2011 and should not be mixed with general household waste at the end of their useful life. For more details kindly visit our website www.daikinindia.com or contact our customer care centre at 1800 102 9300 / 1800 22 9300.



THINK
AIRCONDITIONING
FOR COMMERCIAL
SPACES,
THINK
DAIKIN.



DAIPL-2014/14-SA22-1A

*Terms & conditions apply



THINK INVERTER ACs. THINK DAIKIN.

WORLD'S NO.1 AIRCONDITIONING COMPANY FROM JAPAN.

Index

About Daikin	4-5
The Daikin Difference	6-7
Our Timeline	8-9
Daikin India at a glance	10-11
Application of the product	12-13
Product Line-up	14-15
Non-Inverter Series.....	16-73
Inverter Series	74-111
Outdoor Units	112-123
Controllers	124-129
Function Lineup	130-133
Specifications	134-147
Options	148-152



Daikin, the world leader in airconditioning brings a world full of love to India with its airconditioning solutions. Known for superior Japanese technology, Daikin promises to spread joy in the air. With range and features like never before Daikin creates an environment of comfort through efficient airconditioning. Daikin air conditioners are manufactured keeping in mind different airconditioning needs and also space requirements. Our wide range of air conditioners are easy to install and are apt for residential and commercial usage.

ABOUT DAIKIN

Daikin® is a leading innovator and provider of advanced, high-quality airconditioning solutions for residential, commercial and industrial applications. As World's No. 1 Airconditioning Company, Daikin is committed to delivering airconditioning solutions that enhance the quality of life all around the world. A diverse multinational company, Daikin Industries Ltd. active in airconditioning, chemicals and oil hydraulics, was established in 1924. With headquarters at Osaka, Japan, the Daikin family has more than 51,000 members, working across 60 production base units and 208 consolidated subsidiaries worldwide. As the world's sole manufacturer that develops a long line of products from refrigerants to air conditioners, Daikin advocates comfortable living on the strength of advanced technologies.

Daikin is present in USA, Europe and Russia, Middle East, Africa, Asia, Oceania and Middle-South America. We aim to serve our customers in each of these markets by providing optimal airconditioning products.



Europe/Middle East/Africa

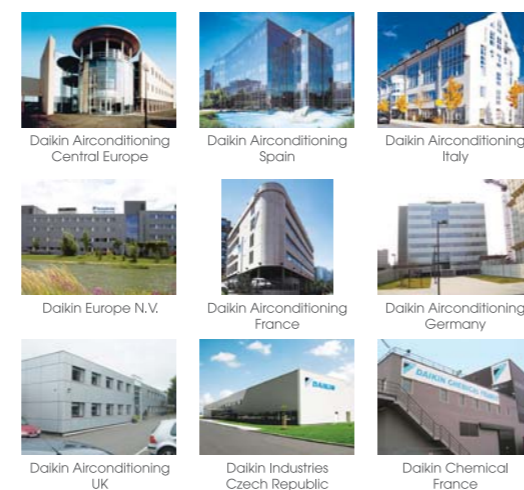

China

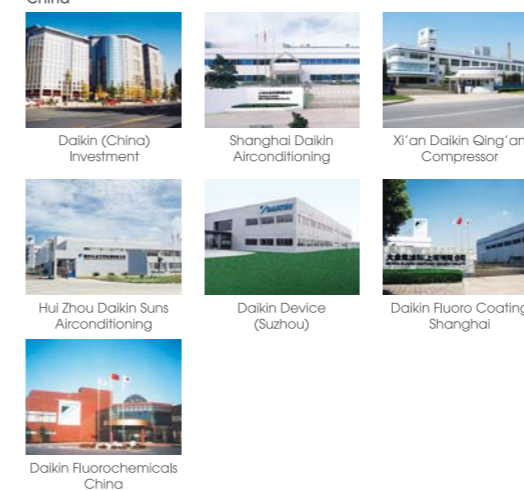

Asia/Oceania

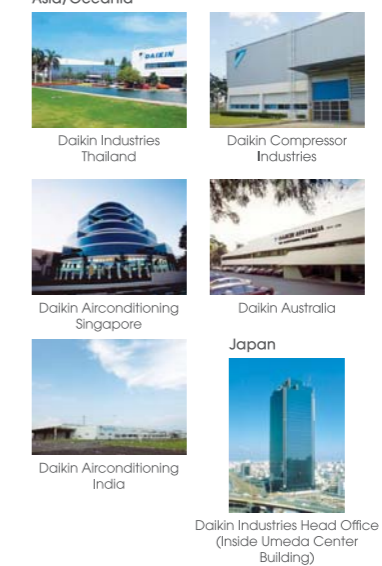

North America/Central & South America



1.

THE DAIKIN DIFFERENCE

As a world leader in technological innovation, we've initiated and funded a wide range of research programs in areas that directly impact our air conditioners — ranging from mechanics and electronics to chemicals and fluorocarbons. With this knowledge, we build absolute Comfort into every product we develop. Pioneering products include the first packaged air conditioner in Japan 1951, and the world's first Variable Refrigerant Volume (VRV) system in 1982. Daikin is committed to explore and adopt cutting-edge technology, in order to continually offer value-added and solution-based products and services to customers.

3.

ENVIRONMENTAL PHILOSOPHY

In February 2002, we created an environmental symbol for the Daikin Group. In environmental protection activities, the little efforts that individuals make add up to big things. The symbol, the Earth in the shape of a green heart, represents a determination on the part of each and every employee of Daikin to think green (think of the Earth and take care of the environment).



As we continue developing our business operations in various fields, it is our mission to proactively develop initiatives to respond to environmental issues. Incorporating environmental initiatives throughout our management must be a priority for us.

In all aspects of our business operations, including product development, manufacturing and sales, we need to formulate initiatives that sustain and improve the environment. Meanwhile, we need to promote the development of new products and the innovation of technologies that will lead to a more environmentally healthy world.

2.

THE LOGO

The triangle shape represents the integration of three technological areas (mechanics, chemistry and electronics) while the upper left direction of the triangle symbolizes Daikin's innovative spirit that aspires toward the future. The two blue colours (corporate colours) used in the corporate logo and the triangle design element benefit Daikin's emphasis on intellect and brightness. Black expresses strength, a sense of positive presence and stability.



4.

PICHONKUN

A mascot that represents Daikin's innovative thrust into the future. Called "PICHONKUN", the new mascot of Daikin is so named because of the sound it makes. Created in Japan, this dew droplet represents the "fresh as morning nature" of Daikin's new range of air conditioners and air-purifiers. PICHONKUN symbolises the best of nature-fresh, natural and eco-friendly.



PICHONKUN
©D.H.T.2000

1924-2012

OUR TIMELINE

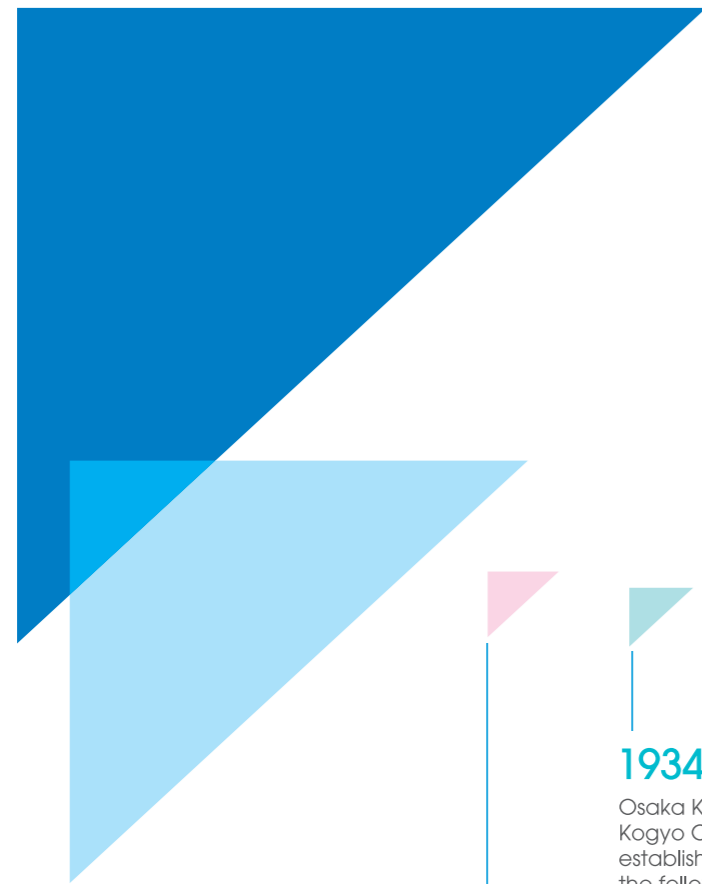

1991
Daikin America, Inc. and MDA Manufacturing, Inc. are established in the U.S.A.

1992
Daikin Chemical Europe is established in Düsseldorf, Germany.

1993
Daikin Airconditioning France S.A. is established in Paris as an airconditioning system sales company.

1995
The industry's first compact room air conditioner to use a swing compressor to save energy is marketed.

1997
All Daikin factories in Japan (Sakai, Yodogawa, Shiga, and Kashima) acquire ISO 14001 certification for environmental management. Presented 32nd Chairman's award by the Japan Society for the promotion of the machine industry for Daikin Swing Compressor.

1998
The Institute of Electrical Engineers of Japan presented the award to Daikin for the first scroll compressor to be equipped with the Reluctance DC motor. Room air conditioners employing the R-410A refrigerant are marketed. Daikin Airconditioning Germany GmbH is established in Munich as an airconditioning system sales company.

1999
Daikin Airconditioning Central Europe GmbH is established in Austria as an airconditioning system sales company.

1924
Akira Yamada founds the Osaka Kinzoku Kogyosho Limited Partnership.

1934
Osaka Kinzoku Kogyo Co., Ltd. is established, with the following corporate logo:  Trial manufacture of a methyl chloride type refrigerator succeeds. The refrigerator is named Mifujirator and production begins.

1936
The Mifujirator refrigerator is delivered to Nankai Railways for trial use as Japan's first air conditioner for trains.

1951
Production of packaged air conditioners begins.

1956
A heat exchanging device is installed on the Soya, an Antarctic research vessel, as a cabin heating system.

2001
Established a company for the manufacture and sale of swing compressors in Bangkok, Thailand, called Daikin Compressor Industries Ltd.

2002
Received the 11th Annual Grand Prize for the Global Environment presented by the Nikkan Kogyou Shimbun.

2003
Daikin is ranked 1st in market share of residential use air conditioners in Japan throughout the fiscal year of 2003.

2006
Acquisition of major global airconditioning manufacturer OYL Industries (Malaysia) with the aim of becoming the No.1 airconditioning manufacturer. Establishment of Environmental Response Department at Daikin Europe N.V. to take the lead in environmental response in the European region.

2008
Receipt of "Eco Products Awards" Japan's Ministry of the Environment's Minister's Prize for "Sho-ene Toban", a building air conditioner remote energy-saving control service.

2009
Acquired Japan's leading air filter company Nippon Muki Co., Ltd.

2012
Acquisition of the major American residential use air conditioner company Goodman to build a solid base for positioning Daikin as the leading company in the global air conditioner market. Launch of residential air conditioner featuring the world's first adoption of the next generation refrigerant HFC32.

1958
Residential-use air conditioners equipped with Japan's first rotary compressor are marketed. The heat-pump type packaged air conditioner is developed.

1963
Osaka Kinzoku Kogyo Co., Ltd. is renamed Daikin Kogyo Co., Ltd. (Renamed Daikin Industries, Ltd. in 1982).

1964
Cool air service by Daikin Aircon begins at J.N.R. Osaka Station. The air conditioner system is thereafter installed in major terminals.

1969
A multiroom airconditioning system with a single outdoor unit is developed. A Freon heater is employed in an air conditioner, combining heating and cooling functions.

1982
Japan's first VRV system is developed. The industry's first single-screw refrigerator is developed.

1984
Daikin becomes first in the world to produce a cumulative total of 1 million packaged air conditioners.

1990
Daikin Industries (Thailand) Ltd. is established in Thailand and begins production of air conditioners.

DAIKIN INDIA AT A GLANCE

Daikin Airconditioning India Pvt. Ltd., a subsidiary of Daikin Industries Ltd., Japan is one of the leading global manufacturers of both Residential and Commercial airconditioning systems. Backed by the superior technology, the organization offers a wide range of energy efficient airconditioning solutions to the Indian customers.

After introducing our superior airconditioning solutions in India in the year 2000, we gained the trust of our valuable customers with our innovative range of products and dedication towards quality. An ISO 14001 certified company, we remain committed to keep customers at the core of everything we do. Imbued with a 'Quality First' global philosophy, we at Daikin walk on to realise our dream for a better world.

"Quality First" is clearly reflected in the value delivered such as low noise level, low power consumption, cooling efficiency, ease of installation, high reliability – all targeted to improve the quality of life.

Daikin India's manufacturing plant at Neemrana, Rajasthan aims at creating products that will make people's lives more comfortable. It is supported by a network of production bases throughout the world and showcases the application of advanced technology and equipment. Our comprehensive quality control system features centrally computerized management of quality and production data to facilitate timely production that bears the stamp of excellent quality.

Daikin Neemrana facility incorporates Daikin's global Environmental Management System (EMS) that has been implemented in the factory to promote adapting procedures for refrigerant handling, resource conservation and waste management.



2000

Daikin enters the Indian market in a JV with Usha Shriram Group at 80:20 stakes respectively as Daikin Shriram Airconditioning.



2002

Daikin introduces VRV technology in India.



2004

Daikin India becomes a wholly owned subsidiary of Daikin Industries Ltd., Japan.



2007

Daikin India relocates HQ to Gurgaon and commences business of McQuay chillers in India.



2008

Groundbreaking ceremony of Daikin India's manufacturing base at Neemrana, Rajasthan.



2009

Production commences at manufacturing plant in Neemrana, Rajasthan.



2010

Fresh round of ₹ 250 crore investment. Thus taking it to a total of ₹ 743 crore.



2012

Production of High Wall Split air conditioners with R-32 refrigerant commences.



2013

Fresh round of ₹ 330 crore investment.

APPLICATION OF THE PRODUCT

1.

RETAIL

Versatility and control are the keys to create a comfortable condition within trading areas and changing rooms that will keep customers shopping. It's important to select a system that offers excellent performance, while minimizing operating costs and energy consumption.



3.

IT & SERVER ROOMS

Computer systems run round the clock and require a controlled temperature environment to operate effectively. Equipment in these rooms can generate a lot of heat and not removing the heat effectively can cause computer servers to malfunction. Downtime from inoperable servers can mean lost business and productivity.



2.

OFFICES / BANKS

The challenge for an office or bank is the ability to effectively heat or cool open plan areas as well as meeting rooms. Cooling a meeting room when it is empty will mean running costs mount up unnecessarily. Conditions within open-plan areas are important for staff comfort levels.



4.

RESTAURANTS

















Guests expect a perfect atmosphere, including comfort conditions. Heat generated from lighting, the kitchen area and the dining area can all contribute to make restaurants uncomfortable with inadequate airconditioning, airconditioning needs to be discreet and flexible to meet the demands of your restaurant and customers.

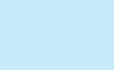

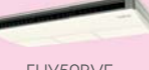







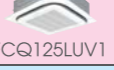

PRODUCT LINE-UP

CAPACITY	TR	0.7~	1.0~	1.5~	1.8~	2.2~	2.5~	3~	3.6~	4~	4.2~	4.6~
	HP	1~	1.5~	2~	2.5~	3~	3.5~	4~	5~	6~	6.5~	7~
	kW	2.6~	3.4~	5.1~	6.4~	7.7~	8.8~	10.5~	12.8~	14.2~	15.0~	16.4~
	Btu/h	8,900~	11,600~	17,500~	21,800~	26,200~	30,000~	35,700~	43,600~	48,400~	51,000~	56,000~
	kcal/h	2,250~	2,930~	4,400~	5,500~	6,600~	7,570~	9,000~	11,000~	12,200~	12,900~	14,100~

NON INVERTER

ROUND FLOW CEILING MOUNTED CASSETTE TYPE (FCNQ) (C/O) <small>(Page 16-25) Specifications Page 134</small>	C/O			FCNQ18MV1		FCNQ26MV1		FCNQ30MV1	FCNQ36MV1		FCNQ48MV1		
	H/P												
CEILING MOUNTED 2x2 CASSETTE TYPE (FF/FF C-SERIES) (C/O & H/P) <small>(Page 26-29) Specifications Page 134-135</small>	C/O	FF10CXV16		FF20CXV16									
	H/P	FFY10CXV16	FFY15CXV16	FFY20CXV16									
CEILING MOUNTED 3x3 CASSETTE TYPE (FHC/FHYC E-SERIES) (C/O & H/P) <small>(Page 30-35) Specifications Page 135-136</small>	C/O			FHC20EXV16	FHC25EXV16	FHC28EXV16		FHC40EXV16	FHC40EXV16				
	H/P			FHYC20EXV16	FHYC25EXV16	FHYC28EXV16		FHYC40EXV16	FHYC40EXV16		FHYC50EXV16		
CEILING MOUNTED CASSETTE TYPE (FHC/FHYC) (C/O & H/P) <small>(Page 36-41) Specifications Page 136-137</small>	C/O				FHC21NUV1	FHC26NUV1		FHC30NUV1	FHC36NUV1		FHC48NUV1		
	H/P			FHYC50KVE	FHYC60KVE	FHYC71KVE			FHYC100KVE	FHYC125KVE	FHYC140KVE		
CEILING SUSPENDED CASSETTE TYPE (FUY) (C/O) <small>(Page 42-47) Specifications Page 137</small>	C/O												
	H/P												
WALL MOUNTED TYPE (FAY) (C/O) <small>(Page 48-53) Specifications Page 138</small>	C/O												
	H/P												
CEILING SUSPENDED TYPE (FH/FHY) (C/O & H/P) <small>(Page 54-59) Specifications Page 138-139</small>	C/O				FH21NUV1	FH26NUV1		FH30NUV1	FH36NUV1		FH48NUV1		
	H/P				FHY60BVE	FHY71BVE		FHY100BVE	FHY125BVE	FHY125BVE			
FLOOR STANDING TYPE (FVY) (C/O) <small>(Page 60-65) Specifications Page 139</small>	C/O												
	H/P												
DUCT CONNECTION LOW STATIC PRESSURE TYPE (FDB/FDYB) (C/O & H/P) <small>(Page 66-69) Specifications Page 140</small>	C/O	FDB25KVE	FDB35KVE		FDB60KVE	FDB71KVE							
	H/P		FDYB35KAVE	FDYB50KAVE	FDYB60KAVE	FDYB71KAVE							
DUCT CONNECTION MIDDLE STATIC PRESSURE TYPE (FDMG/FDYM) (C/O & H/P) <small>(Page 70-73) Specifications Page 141</small>	C/O					FDMG26NUV1		FDMG30NUV1	FDMG36NUV1		FDMG48NUV1	FDMG51NUV1	FDMG56NUV1
	H/P					FDYM03FAV1		FDYM04FAV1	FDYM04FAV1	FDYM05FAV1	FDYM06FAV1		

INVERTER

COMPACT MULTI FLOW CEILING MOUNTED CASSETTE TYPE (FFQ) (C/O & H/P) <small>(Page 74-79) Specifications Page 142</small>	C/O	FFQ25BV1B9	FFQ35BV1B9		FFQ60BV1B9							
	H/P	FFQ25BV1B9	FFQ35BV1B9	FFQ50BV1B9	FFQ60BV1B9							
ROUND FLOW CEILING MOUNTED CASSETTE TYPE (FCQ) (C/O & H/P) <small>(Page 80-89) Specifications Page 143</small>	C/O			FCQ50LUV1		FCQ71LUV1		FCQ100LUV1		FCQ140LUV1		
	H/P											
CEILING SUSPENDED TYPE (FHQ) (C/O & H/P) <small>(Page 90-95) Specifications Page 144</small>	C/O		FHQ50BVV1B		FHQ60BVV1B	FHQ71BVV1B				FHQ125BVV1B		
	H/P		FHQ35BVV1B	FHQ50BVV1B	FHQ60BVV1B	FHQ71BVV1B			FHQ100BVV1B	FHQ125BVV1B		
FLOOR STANDING TYPE (FVQ) (C/O & H/P) <small>(Page 96-101) Specifications Page 145</small>	C/O										FVQ140CVEB	
	H/P											
CEILING MOUNTED SLIM DUCT TYPE (FDXS) (H/P) <small>(Page 102-105) Specifications Page 146</small>	C/O											
	H/P	FDXS25CVMA	FDXS35CVMA	FDXS50CVMA	FDXS60CVMA							
DUCT CONNECTION MIDDLE HIGH STATIC PRESSURE TYPE (FBQ) (C/O & H/P) <small>(Page 106-111) Specifications Page 146-147</small>	C/O			FBQ50DV1	FBQ60DV1				FBQ100DV1		FBQ140DV1	
	H/P											



ROUND FLOW
CEILING MOUNTED
CASSETTE TYPE

FCNQ Series
Cooling Only



R-410A



360° radial airflow pattern creates improved and uniform air distribution.

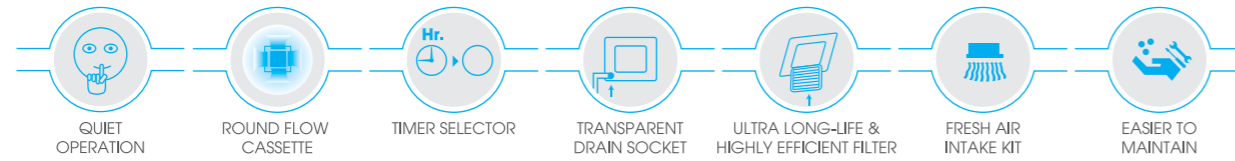

FCNQ18~48MV1 | **1.5TR ~ 4.0 TR**
(COOLING ONLY) (COOLING ONLY)

ACCESSORY REQUIRED FOR INDOOR UNIT

WIRED LCD REMOTE CONTROLLER

Standard



BRC1C61 (Cooling Only)

Note: Remote controller cable not included. Cables must be procured locally.

WIRED LCD REMOTE CONTROLLER WITH WEEKLY SCHEDULE TIMER

Option

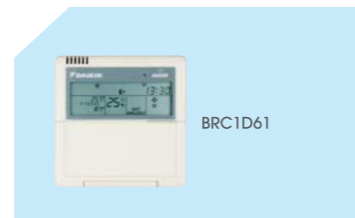

BRC1D61

WIRELESS LCD REMOTE CONTROLLER

Option



A signal receiver must be added to the indoor unit.

BRC7F633F (Cooling Only)

Signal receiver unit (Installed type).

Wireless remote controller and signal receiver unit are sold as a set.

NAVIGATION REMOTE CONTROLLER

Option

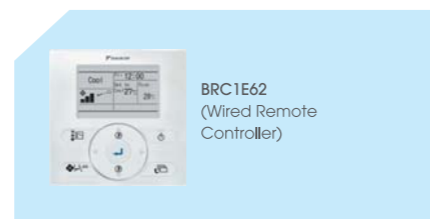

BRC1E62 (Wired Remote Controller)

Note: Remote controller cable not included. Cables must be procured locally.

1 FEATURES

Sound Level
31/28dB(A)
High Low

FCNQ18MV1

Feature	Comfort				Remote Controller		Cleanliness	Work & Servicing			Control Features			Options	Others
	Cooling Only	•	•	•	•	•	•	•	•	•	•	•	•	•	•

*1Applicable when wired remote controller is used *2Installable on max. 3.5 m high ceiling *3Applicable when BRC1E62 is used *4Applicable when BRC1D61 or BRC1E62 is used *5Applicable when BRC1C61 is used *6Applicable to R30-48M *7Applicable to R18-26M *8For outdoor units

2 COMFORT

ROUND FLOW CASSETTE

- Comfortable airflow

360° airflow with improved temperature distribution.

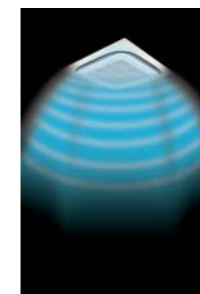

Conventional 4-way flow type

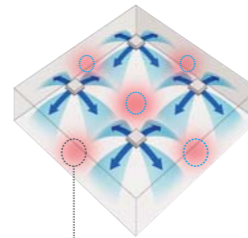

4-way flow leaves areas that cannot be covered.



Round Flow type

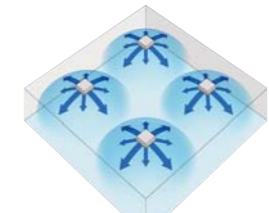

360° airflow gives uniform airflow distribution.

Greater comfort. Improved energy-saving.

AVOIDS NON-UNIFORM TEMPERATURE AND DISCOMFORT CAUSED BY DRAFTS

Comfort enhanced by Round Flow

With uniform temperature distribution

- 360° airflow

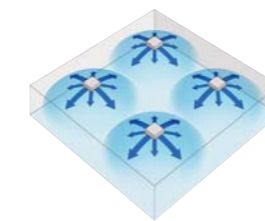

Airflow distribution creates uniform comfort throughout the space.

Greater comfort
Improved energy-saving

If you raise the set temperature by 1 to 1.5°C, and velocity is decreased by 25%, you still obtain the same temperature and comfort.

- Air movement is gentle with Round Flow



Enhanced Comfort



360° airflow can maintain comfort even if air discharge speed is lower.

OPTIMAL COMFORT AND CONVENIENCE ASSURED BY AIR DISCHARGE MODES

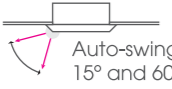
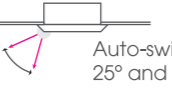
Note Air direction is set to the standard position when the unit is shipped from the factory. The position can be changed from the remote controller.

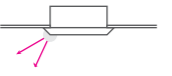
Blow direction	Standard setting	Setting to prevent soiling of ceiling*
Desired situation	Standard position to prevent draft.	Recommended for shops with light coloured ceilings that must be kept spotless.
Auto-swing	 Auto-swing between 15° and 60°	 Auto-swing between 25° and 60°
Blow direction can be set to 5 levels	 Settable to 5 different levels between 15° and 60°	 Settable to 5 different levels between 25° and 60°
Auto blow direction control	 The last discharge direction is saved in memory and automatically set the next time the unit is turned ON.	

*Closing of the corner discharge outlets is recommended.

SUITABLE FOR HIGH CEILINGS

Even in spaces with high ceilings, a comfortable airflow is carried down to the floor level.

CRITERIA FOR CEILING HEIGHT AND NUMBER OF AIR DISCHARGE OUTLETS

		Number of air discharge outlets used							
		18-36				42-48			
Ceiling height	Standard	All round flow	4-way flow	3-way flow	2-way flow	All round flow	4-way flow	3-way flow	2-way flow
	High ceiling (1)	2.7 m	3.1 m	3.0 m	3.5 m	3.2 m	3.4 m	3.6 m	4.2 m
	High ceiling (2)	3.0 m	3.4 m	3.3 m	3.8 m	3.6 m	3.9 m	4.0 m	4.2 m
		3.5 m	4.0 m	3.5 m	—	4.2 m	4.2 m	4.2 m	—

Note: Factory settings are for standard ceiling height and all-round flow. High ceiling settings (1) and (2) are set with the remote controller.

ADAPTS EASILY TO THE INSTALLATION SPACE

Because air flows out from corner outlets, comfort spreads more widely.

Typical flow patterns

There are a total of 23 flow patterns.

All-round flow



(E.g., installed in middle of ceiling)

3-way flow



(E.g., installed near a wall)

L-shaped 2-way flow



(E.g., installed in a corner)

Opposite 2-way flow



(E.g., installed in a long room)

4-way flow also possible.

Note: Whatever the discharge direction, the same type of panel is used. If installing for other than all-round flow, an air discharge outlet sealing member (option) must be used to close each unused outlet. Operation sound increases when using 2-way or 3-way flow.

TWO SELECTABLE TEMPERATURE-SENSORS

Both indoor unit and wired remote controller (option) contain temperature-sensors. Temperature sensing can be set at the unit or, to further improve comfort level, closer to the target area at the wired remote control. This feature requires initial setting by the installer.

Temperature-sensor on indoor unit must be used when the air conditioner is controlled from another room. Wireless remote controller does not have a temperature-sensor.

SWITCHABLE FAN SPEED: High/Low

High setting provides maximum reach while low setting minimises drafts.

TIMER SELECTOR

Operation starts when the preset time of the ON timer elapses and stops when the preset time of the OFF timer elapses.

3 CLEANLINESS

EXTERNAL PANELS ARE TREATED WITH A COATING THAT REPELS DIRT

- Grime prevention and bactericidal coating: Makes cleaning easier.

To prevent dirt sticking to the external panels, they have been coated with a surface treatment.

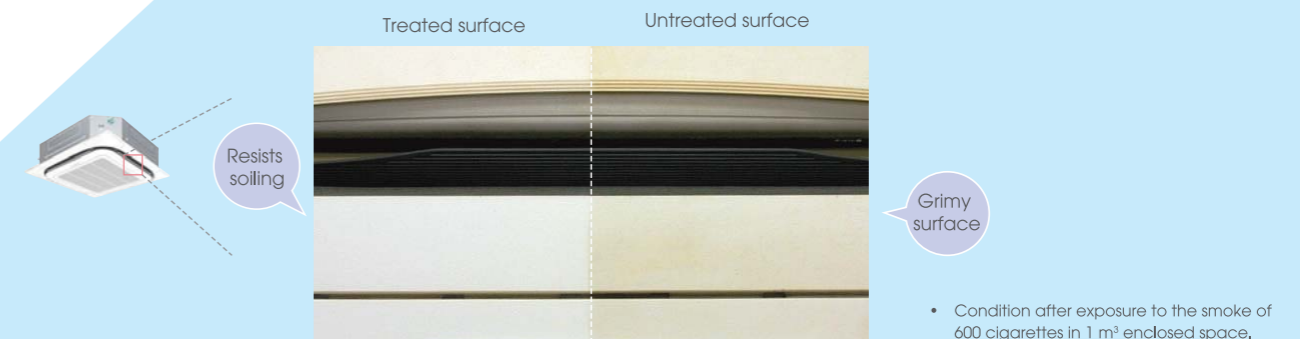

- Non-flocking horizontal louvres
Dew does not easily form and dirt does not cling to non-flocking louvres. It is easy to clean.

- Filter has bactericidal treatment
Prevents microorganisms growing out of the dust and moisture that adheres to the filters.

4 WORK & SERVICING

QUICK AND EASY TO INSTALL

Just 256 mm high. Can be installed in tight ceiling spaces (18-26).



Note: ¹298 mm high with 30-48

EASY HEIGHT ADJUSTMENT

Each corner of the unit has an Adjuster Pocket that lets you easily adjust the unit's suspended height.

Note: If the wireless remote control option is installed, a light receptor unit is housed in one of the adjuster pockets.

EASIER CONNECTION WITH THE CENTRALISED CONTROL SYSTEM

EASIER TO MAINTAIN

The condition of the drain pan and drain water can be checked by removing the drain plug and intake grille.

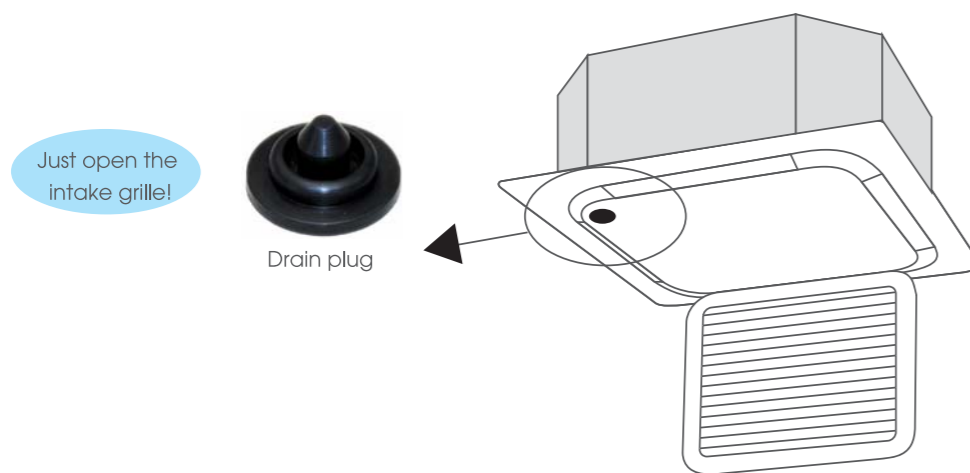

With ultra long-life filters (option), maintenance is not required in normal shops or offices for up to four years.

PANEL SPACER

Use when only minimal space is available between drop ceilings and ceiling slabs.

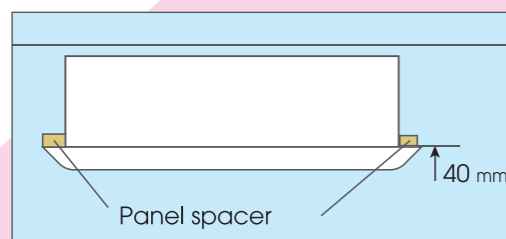

Note: Some ceiling constructions may hinder installation. Contact your Daikin Dealer before installing your unit.

UNIFIED SQUARE PANELS

Panels are the same size as the FCNQ18-48. Maintains a neat appearance where multiple units are installed.

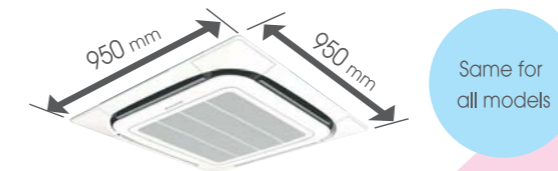

Same for all models

COMPACT BODY AND QUIET OPERATION

Indoor unit	dB(A)	
	High	Low
18	31	28
21	35	28
26	35	28
30	43	32
36	43	32
42	44	34
48	44	36

Note: Anechoic chamber conversion value, measured according to JIS parameters and criteria. During operation these values are somewhat higher owing to ambient conditions.

ROUND FLOW TYPE: LIST OF OPTIONAL PARTS REQUIRED TO ACHIEVE DIFFERENT FLOW PATTERNS

For each flow pattern – all round, 4-way, 3-way, 2-way, branch duct connection – the compatibility of each independently installed option (shown in the column on the left) to accessory options (listed across the top of each table) is shown in the cells where the relevant row and column intersect. A circle (o) indicates compatibility, and a cross (x) indicates incompatibility. Any options not shown below are not suitable for independent or accessory installation.

All round flow 4-way flow

Independently installable optional parts	Optional accessory parts							
	Panel Spacer ¹	Wireless remote controller	Fresh air intake kit (Chamber type) ^{1,2}	Fresh air intake kit (direct mount)	High-humidity operation kit	High-efficiency filter ²	Ultra-long-life filter ²	
Panel/grille related	Panel spacer ¹	o	o	o	o	o	o	
Operation control related	Wireless remote controller	o	o	o	o	o	o	
Auxiliary function related	Fresh air intake kit (Chamber type) ^{1,2}	o	o	x	x	o	o	
	Fresh air intake kit (direct mount)	o	o	x	o	o	o	
Filter related	High-humidity operation kit	x	o	x	o	x	o	
	High-efficiency filter ²	o	o	o	x	o	x	
	Ultra-long-life filter ²	o	o	o	o	x	o	

3-way flow 2-way flow

Independently installable optional parts	Optional accessory parts							
	Panel Spacer ¹	Wireless remote controller	Fresh air intake kit (Chamber type) ^{1,2}	Fresh air intake kit (direct mount)	High-humidity operation kit	High-efficiency filter ²	Ultra-long-life filter ²	
Panel/grille related	Panel spacer ¹	o ³	o ³	o ³	x	x	o ³	
Operation control related	Wireless remote controller	o ³	o	o	o	x	o	
Auxiliary function related	Fresh air intake kit (Chamber type) ^{1,2}	o ³	o	x	x	x	o	
	Fresh air intake kit (direct mount)	o ³	o	x	o	x	o	
Filter related	High-humidity operation kit	x	o	x	o	x	o	
	Ultra-long-life filter ²	o ³	o	o	o	x	x	

Branch duct connection

Independently installable optional parts	Optional accessory parts							
	Panel Spacer ¹	Wireless remote controller	Fresh air intake kit (Chamber type) ^{1,2}	Fresh air intake kit (direct mount)	High-humidity operation kit	High-efficiency filter ²	Ultra-long-life filter ²	
Branch duct ¹ (Chamber type)	1-way branch / unit 3-way flow	o	o	o	o ⁴	x	x	o
(Round duct type)	2-way branch / unit 2-way flow	x	o	o	o ⁴	x	x	o
	1-way branch / unit 2-way flow	x	o	o	o ⁴	x	x	o

¹In some cases, depending on how the unit is embedded in the ceiling, use of branch ducts and fresh air intake kits may not be possible. Before starting installation work make sure to check whether or not joint installation is possible. In particular, ensure that the lower fixing position caused by the addition of panel spacers is acceptable.

²Use a chamber connection kit if two different types of optional chambers are used together. In this case, the fresh air intake kit must be installed in the upper position.

³It is not possible to use panel spacers in a 2-way flow installation.

⁴It is not possible to install a branch duct on the same side to which a fresh air intake kit (direct mount) is installed.

DRAIN PUMP IS EQUIPPED AS STANDARD ACCESSORY WITH 850 MM LIFT

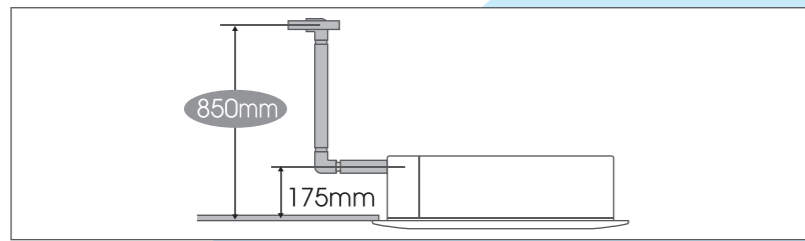

TRANSPARENT DRAIN SOCKET

Because the drain socket is transparent, after the drain piping has been installed, it is easy to check if the drain comes out through the socket.



THE UNITS CAN BE INSTALLED IN THE FOLLOWING DIFFERENT WAYS

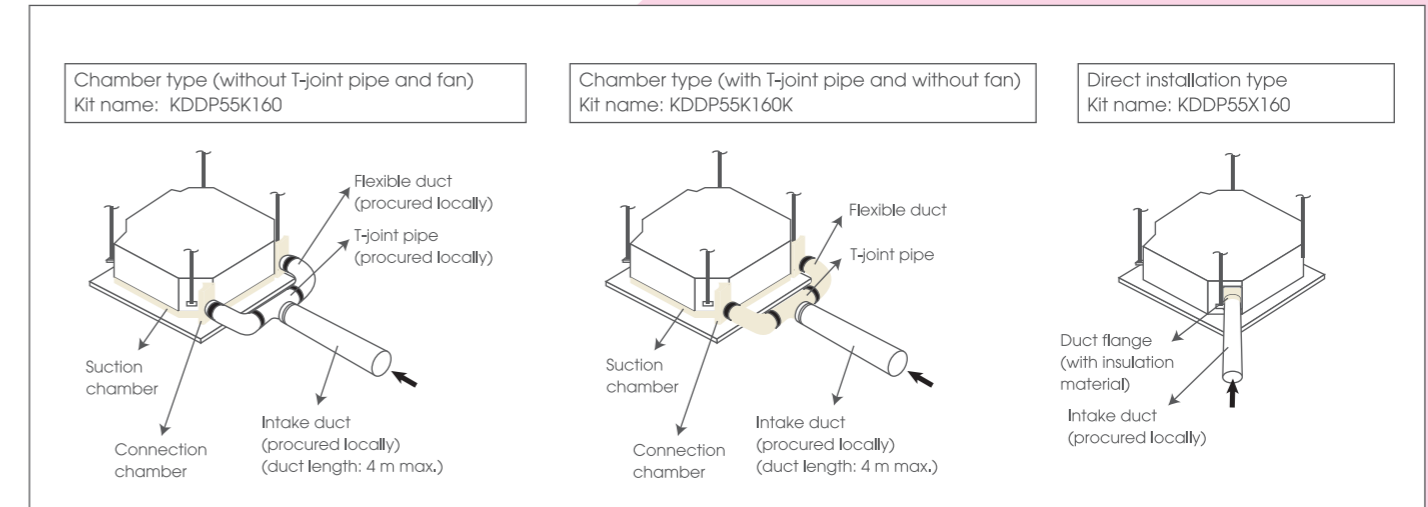

Note: Use of options will increase operating sound.

ALL MODELS SUSPENDED WITHOUT LIFT INSTALLED IN ANY DIRECTION

Since the orientation of the intake grille can be adjusted after installing, the direction of the intake grille lines can be unified when multiple units are installed.

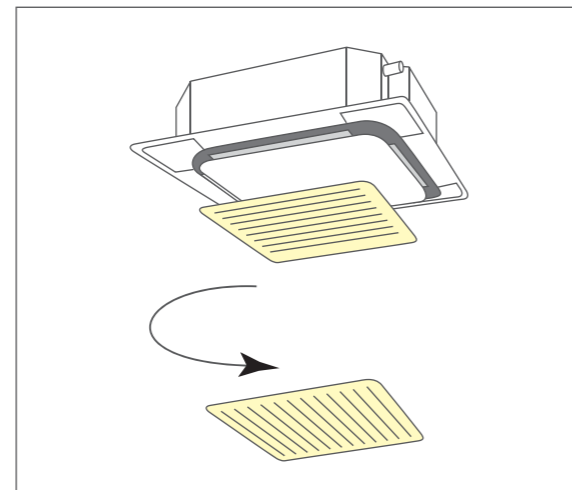

SEALING MEMBER OF AIR DISCHARGE OUTLET

Sealing members block air discharge openings not used in 2-way or 3-way blow.

BRANCH DUCT (DIRECT-CONNECTION ROUND DUCT)

A round duct can be attached without the need for a chamber. A flanged port for direct connection of a round duct is provided. An existing branch duct chamber can also be fitted (square slit hole).

5 OPTIONS

ULTRA LONG-LIFE FILTER

Even in smoky environments where the air conditioner is on most of the time, the ultra long-life filter only has to be changed once a year.

Smoky atmosphere: annual filter change.
 *For dust concentration of 0.3mg/m³ (Requires separately sold Air Cleaner.) 1 year (Approx. 5,000 hr) = 15 hr/day x 28 day/month x 12 month/year.
 In ordinary stores and offices, filter change every 4 years.
 *For dust concentration of 0.15mg/m³ 4 years (Approx. 10,000 hr) = 8 hr/day x 25 day/month x 4 years.

FRESH AIR INTAKE KIT

Using this kit, a duct can be fitted to increase the intake of outdoor air.

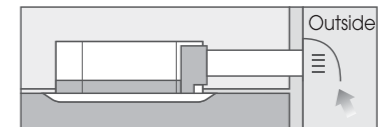

*Connecting ducts, insect nets, fire dampers, air filters, and other parts should, as required, be procured locally.
 **Outside Air fan interlocked with airconditioning unit is necessary. Optional PCB (KRP1C63) is required for interlocking.
 ***It is recommended that the volume of outdoor air introduced through the kit is limited to 10% of the maximum airflow rate of the indoor unit. Introducing higher quantities will increase the operating noise and may also influence temperature setting.

HIGH-EFFICIENCY FILTER

Available in two types: 65% and 90% colorimetry.



CEILING
MOUNTED 2X2
CASSETTE TYPE

FF/FFY C-Series
Cooling Only & Heat Pump



R-22

Compact unit design

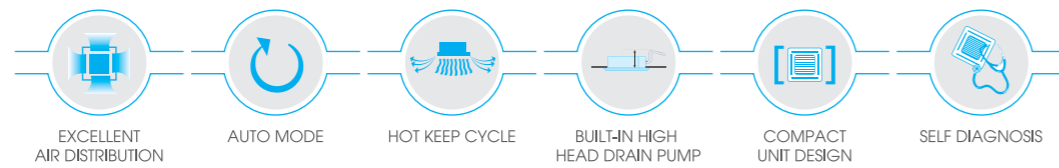

FF10~20 (COOLING ONLY)
FFY10~20 (HEAT PUMP)

0.75 TR ~ 1.5 TR
(COOLING ONLY/HEAT PUMP)

ACCESSORY REQUIRED FOR INDOOR UNIT

WIRELESS HANDSETS

Standard



BRC52A62
(Cooling Only)



BRC52A61
(Heat Pump)

WIRED HANDSETS

Option

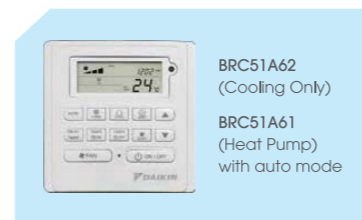

BRC51A62
(Cooling Only)
BRC51A61
(Heat Pump)
with auto mode

2 COMFORT

EXCELLENT AIR DISTRIBUTION

Combining 4 ways air discharge and air swing function, conditioned air is evenly distributed to every corner of the room.

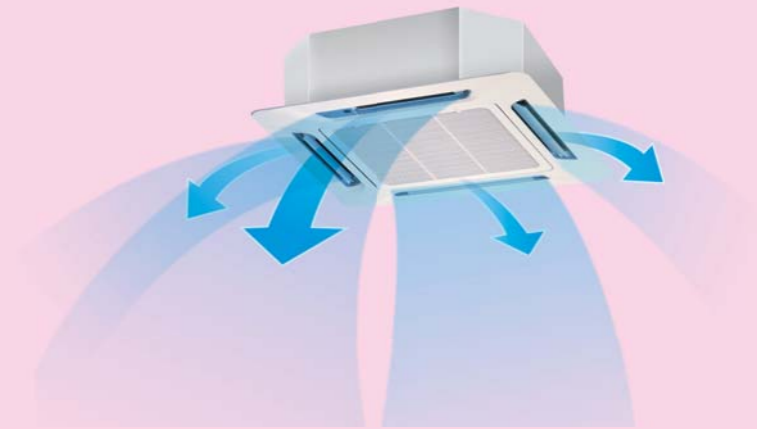

AUTO MODE

Auto Mode allows the setting to change automatically between cool and heat mode depending on the room temperature and the set temperature required.

HOT KEEP CYCLE

During heat mode hot keep cycle, the fan will run at low speed during the thermostat cycle off. As a result, one will not feel the draft of cold air discharge from the unit. Option of fan stop or fan run at specific interval timing can also be selected.

3 WORK & SERVICING

BUILT-IN HIGH HEAD DRAIN PUMP

The unit comes with a 700 mm built-in, high head drain pump. A safety float is incorporated in the drain pump to monitor its water level.

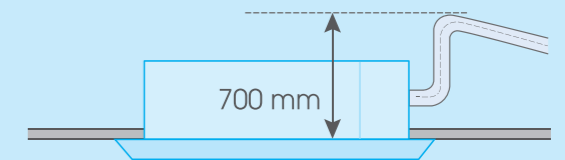

COMPACT UNIT DESIGN

Ceiling Cassette C-Series body dimension is only 570 mm x 570 mm which can easily fit into a 600mm ceiling grid.

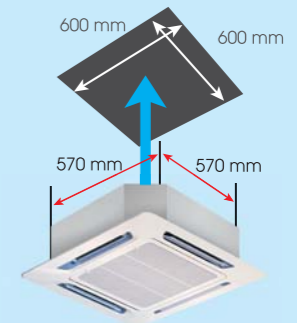

SELF DIAGNOSIS

This intelligent feature helps to detect faults or malfunctioning in the system and give user a warning by blinking of the LED lights.

1 FEATURES

Sound Level
41/38/34 dB(A)
High Middle Low
FF15CXV16/FFY15CXV16

Feature	Comfort				Airflow			Work & Servicing	IAQ	Fin Type	Control Features			Power Supply		Options				
	Quiet Mode	Dry Mode	Auto Mode	Sleep Mode	Excellent Air Distribution	Hot Keep Cycles	Selectable Fan Speed	Automatic Vertical Swing	4 Way Air Discharge	Self Diagnosis	Built-in-High Head Drain Pump	Washable Saramet Filter	Anti-Corrosion Hydrophilic Gold Fin	With Wireless Remote Controller	With Wired Remote Controller	Auto Random Restart	Power From Indoor	Power From Outdoor	Fresh Air Intake	Branch Duct Connection
Model																				
Cooling Only	—	•	•	•	•	—	•	•	•	•	•	•	•	*	•	•	—	•	•	•
Heat Pump	—	•	•	•	•	•	•	•	•	•	•	•	•	*	•	•	—	•	•	•

*Option



CEILING
MOUNTED 3X3
CASSETTE TYPE

FHC/FHYC E-Series
Cooling Only & Heat Pump



Modern & elegant design

R-22

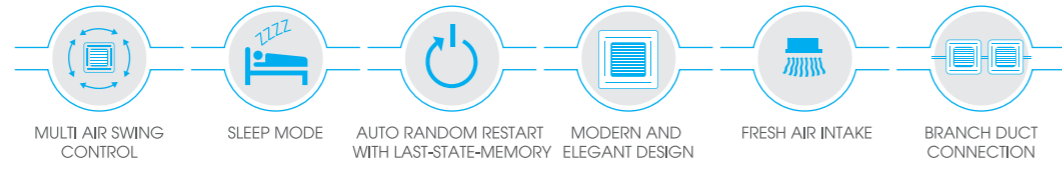

FHC20~50 (COOLING ONLY) 1.5 TR ~ 4.0 TR
 FHYC20~50 (HEAT PUMP) (COOLING ONLY/HEAT PUMP)

2 COMFORT

MULTI AIR SWING CONTROL

STANDARD SETTING

Louver is set to swing at the maximum angle for gentle drafts.

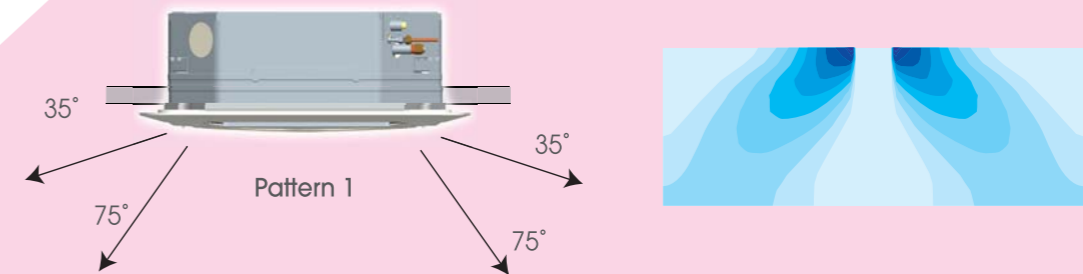

DRAFT PREVENTION SETTING

With the aid of Coandă effect, direct draft which may lead to discomfort can be avoided.

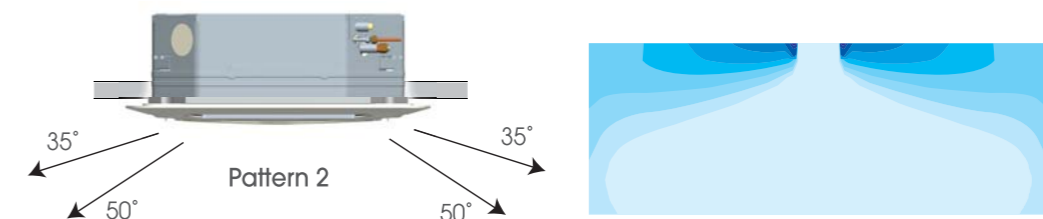

SOIL PREVENTION SETTING

Even distribution of cooling whilst ensuring ceiling to be kept spotless.

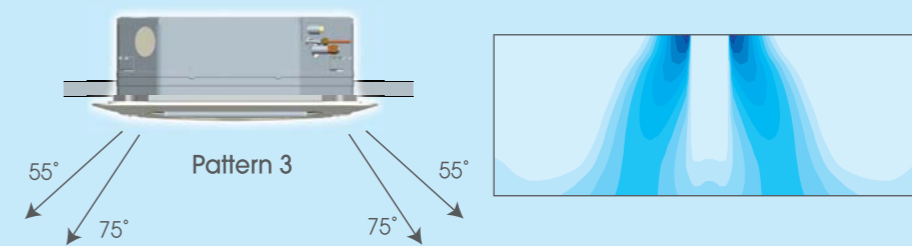

Note: 1. The default setting is pattern 1. The air swing pattern can be selected via wireless remote control. 2. Applicable for Ceiling Cassette E series.

ACCESSORY REQUIRED FOR INDOOR UNIT

WIRELESS HANDSETS

Standard



BRC52A62 (Cooling Only)



BRC52A61 (Heat Pump)

WIRED HANDSETS

Option

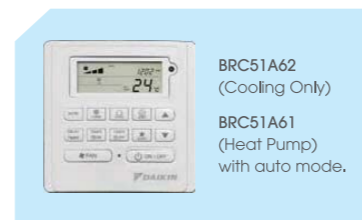

BRC51A62 (Cooling Only)
 BRC51A61 (Heat Pump) with auto mode.

1 FEATURES

Sound Level
34/32/30/28 dB(A)
 High Middle Low SL
 FHC20EXV16/FHYC20EXV16

Feature	Comfort				Airflow			Work & Servicing		IAQ		Fin Type		Control Features			Power Supply		Options	
	Quiet Mode	Dry Mode	Auto Mode	Sleep Mode	Excellent Air Distribution	Multi-Comfort 3 Air Swing Pattern	Selectable Fan Speed	Automatic Vertical Swing	4 Way Air Discharge	Self Diagnosis	Built-In-High Head Drain Pump	Washable Saranet Filter	Anti Corrosion Hydrophilic Gold Fin	With Wireless Remote Controller	With Wired Remote Controller	Auto Random Restart	Power From Indoor	Power From Outdoor	Fresh Air Intake	Branch Duct Connection
Model																				
Cooling Only	•	•	•	•	•	•	•	•	•	•	•	•	•	•	•	•	•	•	•	•
Heat Pump	•	•	•	•	•	•	•	•	•	•	•	•	•	•	•	•	•	•	•	•

*Option **Yes for R(Y)35DGXV1/ 40/50DGXY1

SLEEP MODE

Once activated, sleep mode ensures a comfortable environment for restful sleep. Depending on the mode, set temperature is increased/decreased gradually according to normal sleeping temperature patterns.

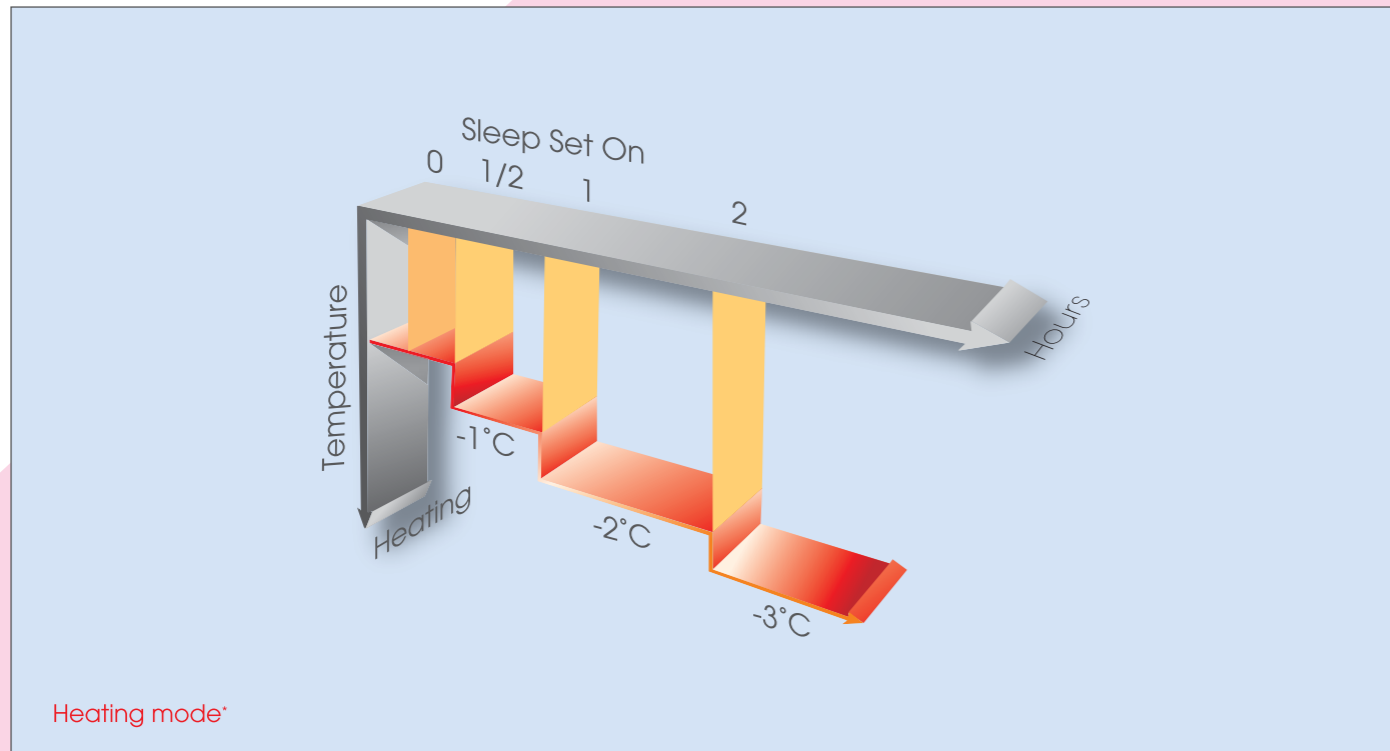

Heating mode*

*Heat Pump models only

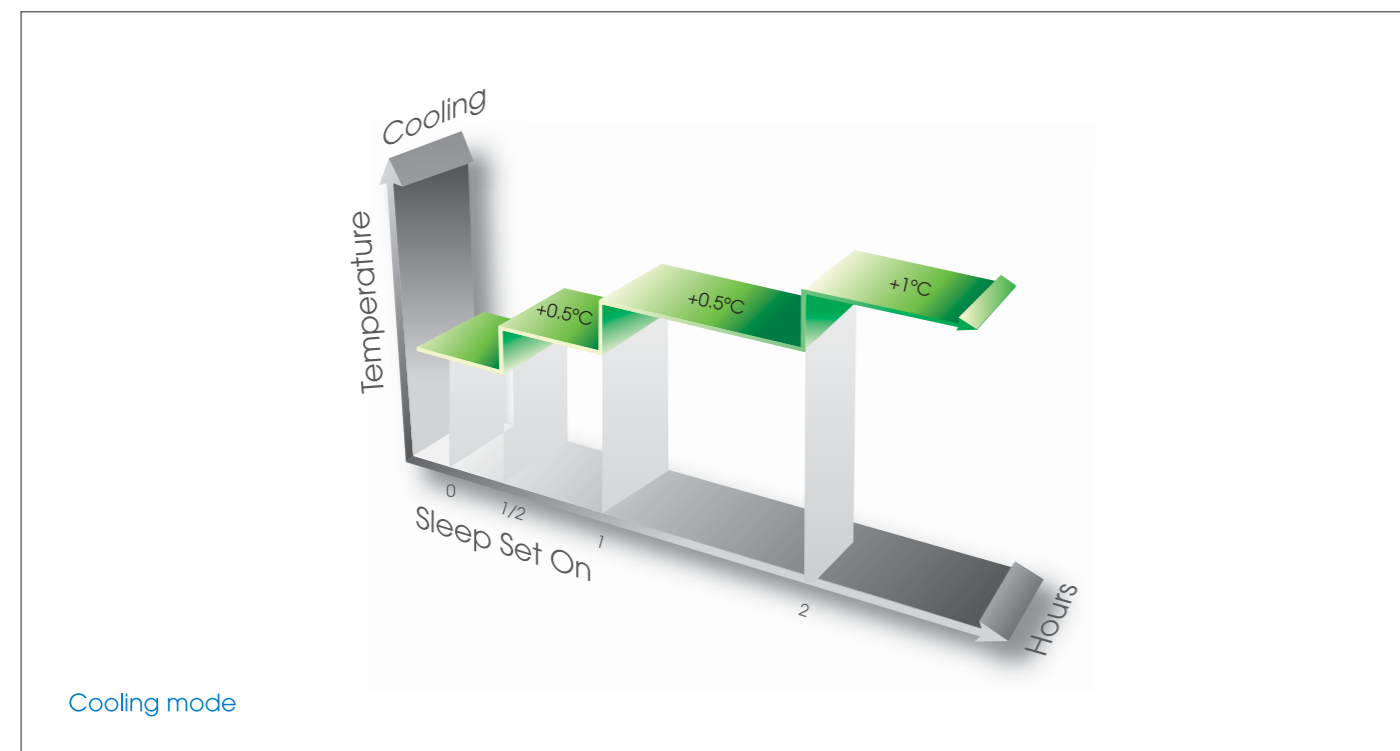

Cooling mode

AUTO RANDOM RESTART WITH LAST-STATE-MEMORY

In the event of a sudden power failure during operation, unit restarts automatically in 64 different recovery timing patterns (within 180 seconds to 244 seconds) and the unit will operate based on the previous setting (operating mode, temperature setting and fan speed). This ensures that air conditioners in the same building resume randomly instead of all units resuming at the same time, preventing power surge after a blackout.

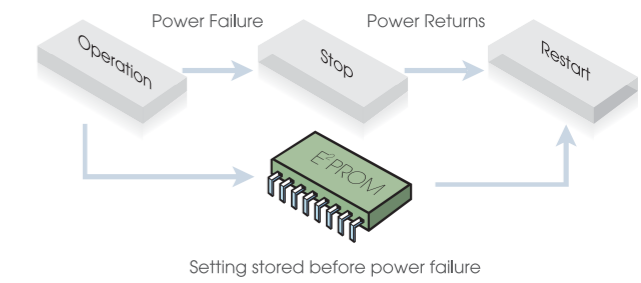

3 WORK & SERVICING

MODERN AND ELEGANT DESIGN

It is designed with unique "round" side contour and new LED light location. Rotatable intake grille promotes uniform installation.

FRESH AIR INTAKE

Keeps the introduction of fresh air intake within 20% of total air flow.

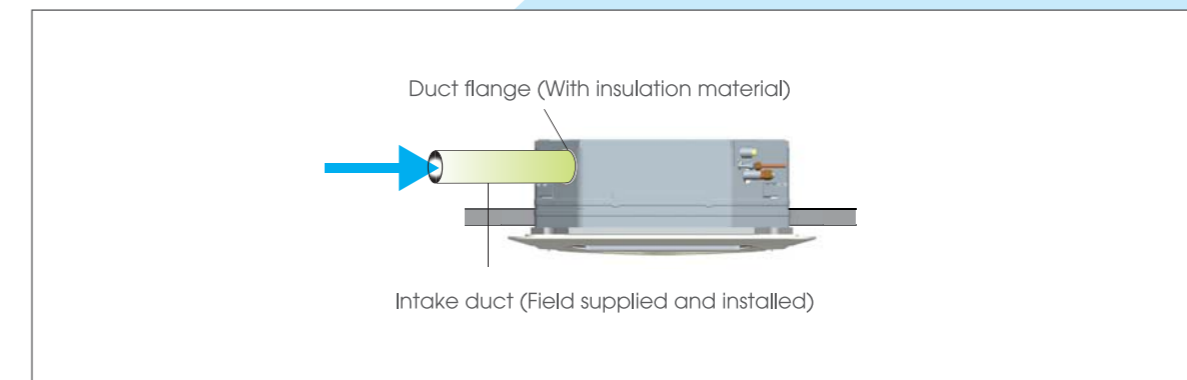

BRANCH DUCT CONNECTION

Improves airflow distribution when there is an obstruction. It allows to be used for airconditioning of two rooms simultaneously.

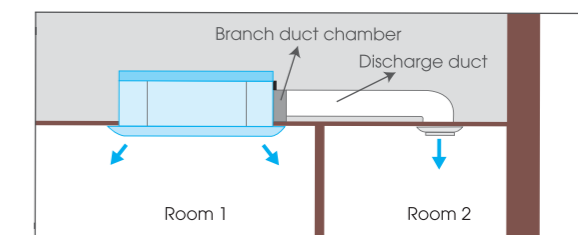



CEILING MOUNTED CASSETTE TYPE

FHC/FHYC Series
Cooling Only & Heat Pump



Décor-blending form and easy installation in new or old buildings.

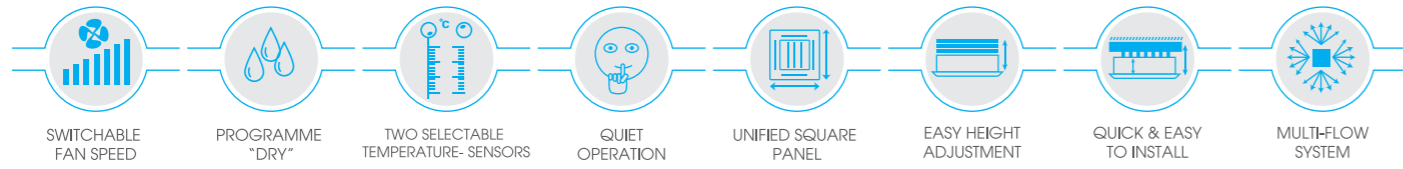

FHC18~48NU (COOLING ONLY)
FHYC50~140LU (HEAT PUMP)

1.5 TR ~ 4 TR
(COOLING ONLY/HEAT PUMP)

ACCESSORY REQUIRED FOR INDOOR UNIT

LCD WIRED REMOTE CONTROLLER

Standard



Note: Remote controller cable not included. Cables must be procured locally.

LCD WIRELESS REMOTE CONTROLLER

Option



BRC7C613W (Cooling Only)
BRC7C612W (Heat Pump)

A signal receiver must be added to the indoor unit.
Signal receiver unit (Installed type)

Note: Wireless remote controller and signal receiver unit are sold as a set.

1 FEATURES

Sound Level
33/29 dB(A)
High Low
FHC18NUV1/FHYC50KVE

Feature	Comfort										Work & Servicing				Control Features				Option		Others										
	Auto swing	Swing pattern selection	Draft prevention function	Switchable fan speed	Programme "Dry"	High ceiling application	Two selectable thermo-sensors	Hot start	Year-round cooling applicable	Timer selector	Mould resistant treatment for filter	Drain water lift-up mechanism	Pre-charged for up to 30m	Pre-charged for up to 10m	Filter sign	Ceiling soiling prevention	Low gas pressure detection	Emergency operation	Self-diagnosis function	Auto-restart	Auto-cooling/heating change-over	Control by 2 remote controllers	Control by 1 remote controller	External command control	Central remote control	Interlock control	Long-life filter	High-efficiency filter	Fresh air intake kit	Twin / triple / double twin multi operation	PE fin
Model	•	•	•	•	•	•	•	•	•	•	•	•	•	•	•	•	•	•	•	•	•	•	•	•	•	•	•	•	•	•	•
Cooling Only	•	•	•	•	•	•	•	•	•	•	•	•	•	•	•	•	•	•	•	•	•	•	•	•	•	•	•	•	•	•	•
Heat Pump	•	•	•	•	•	•	•	•	•	•	•	•	•	•	•	•	•	•	•	•	•	•	•	•	•	•	•	•	•	•	•

*1 Applicable when wired remote controller is used *2 Applicable to R(Y)71-140 outdoor units

2 COMFORT

OPTIMAL COMFORT AND CONVENIENCE ASSURED BY 3 AIR DISCHARGE MODES

Air direction	Draft prevention setting	Standard setting	Setting to prevent soiling of ceiling
Desired situation	When drafts are unwanted	For gentle drafts (Ceiling is stained)	When ceiling must be kept spotless
Auto swing	Auto swing between 10° and 40°	Auto swing between 10° and 65°	Auto swing between 30° and 65°
5-level blow direction setting	Settable to 5 different levels between 10° and 40°	Settable to 5 different levels between 10° and 65°	Settable to 5 different levels between 30° and 65°
Draft prevention (In heating mode)	At heating startup and thermo OFF*, air discharge is automatically set to a near horizontal 10° to prevent direct exposure to cool air drafts.	At heating startup and thermo OFF*, air discharge is automatically set up 30° to prevent both direct exposure to cool air drafts and contact with ceilings.	
Auto blow direction control	The last blow direction is saved in memory and automatically set the next time the unit is turned ON (Initial setting is 30° for cooling).		

Note: Blow direction is set to the standard position when the unit is shipped from the factory. The position can be changed from the remote controller.

INSTALLABLE ON HIGH CEILINGS

Criteria for ceiling height and number of blow outlets.

		Number of air discharge outlets used					
		18NU-26NU			30NU-48NU		
Ceiling height	Standard	2.7 m	3.0 m	3.5 m	3.2 m	3.6 m	4.2 m
	High ceiling (1)	3.0 m	3.3 m	3.8 m	3.6 m	4.0 m	4.2 m
	High ceiling (2)	3.5 m	3.5 m	—	4.2 m	4.2 m	—

Note: Units are set to standard ceiling height and 4-way blow when shipped from the factory. High ceiling (1) and (2) are set from the remote controller.

		Number of below outlets used					
		50~71			100~140		
Ceiling height	Standard	2.7 m	3.0 m	3.5 m	3.2 m	3.6 m	4.2 m
	High ceiling (1)	3.0 m	3.3 m	3.8 m	3.6 m	4.0 m	4.2 m
	High ceiling (2)	3.5 m	3.5 m	—	4.2 m	4.2 m	—

Note: Units are set to standard ceiling height and 4-way blow when shipped from the factory. High ceiling (1) and (2) are set from the remote controller.

SWITCHABLE FAN SPEED: High/Low

Draft resistance has been reduced by incorporating into a single unit, an impeller and a diffuser to control air flow inside the unit. The Diffuser Turbo Fan is compact and quiet during operation.

PROGRAMME "DRY"

Dehumidification is microprocessor controlled to prevent abrupt and uncomfortable changes in air temperature.

TWO SELECTABLE TEMPERATURE - SENSORS

Both indoor unit and wired remote controller (option) contain temperature-sensors. Temperature sensing can be set at the unit or, to further improve comfort level, closer to the target area at the wired remote control.

Temperature-sensor on indoor unit must be used when the air conditioner is controlled from another room.
Wireless remote controller does not have a temperature-sensor.

A newly shaped air discharge opening increases flow without increasing wind speed, hence discharged air reaches farther than before.

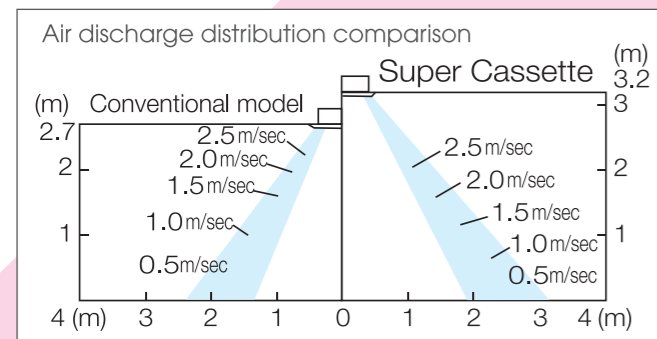

COMPACT BODY AND QUIET OPERATION

Indoor units use an aerodynamically designed Diffuser Turbo Fan.

Cooling Only

Indoor unit	Capacity HP	High	Low
18NU	2	33	29
21NU	2.5	35	30
26NU	3	35	30
30NU	3.5	39	34
36NU	4	42	36
42NU	5	42	36
48NU	6	42	36

Sound Level dB(A) (220V)

Heat Pump

Indoor unit	High	Low
50	33	29
60	35	30
71	35	30
100	39	34
125	42	36
140	44	37

Sound Level dB(A) (220V)



MULTI-FLOW SYSTEM

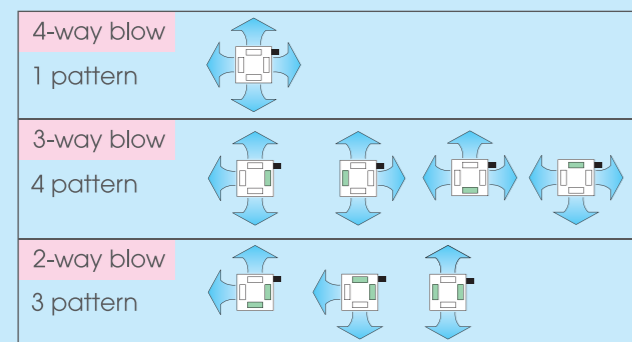

Note: For 3-way or 2-way flow installation, the sealing member of air discharge outlet (option) must be used to close off the unused outlet(s).

Air direction can be selected according to installation



■ denotes piping direction.
■ denotes sealing member of air discharge outlet (option).

Note: Running noise increases when using 2-way or 3-way blow.

3 WORK & SERVICING

UNIFIED SQUARE PANELS

All models from 18NU to 48NU use the same size panel. Multiple unit installations maintain a physical uniformity that is aesthetically pleasing and make it easier to plan ceiling lighting systems and to design interiors.

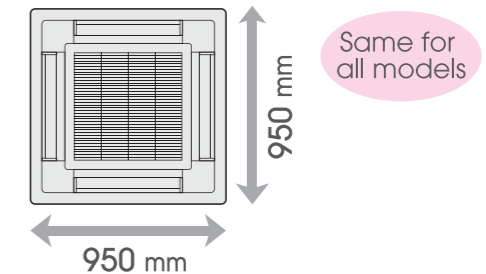

QUICK AND EASY TO INSTALL

Just 240 mm high. Installable in tight ceiling spaces (18NU-26NU) & (35~71LU).

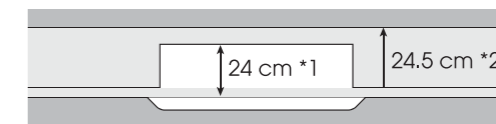

*1 28.9 cm tall with 36~48NU & 100~140LU
*2 30.4 cm tall with 36~48NU & 100~140LU

EASY INSTALLATION FOR OPTIONS

Options like the High Performance Filter are buckled into place rather than screwed as before, which makes installation quick and easy for anyone.

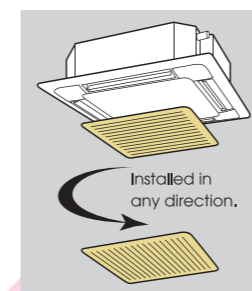

- All models suspended without uppers
- Installable in any direction
- Provided with drain pump mechanism

EASY HEIGHT ADJUSTMENT

Each corner of the unit has an Adjuster Pocket that lets you easily adjust the unit's suspended height.

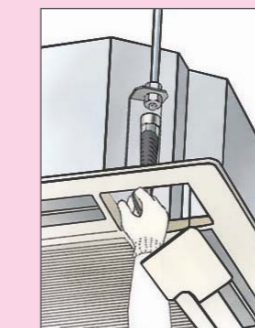
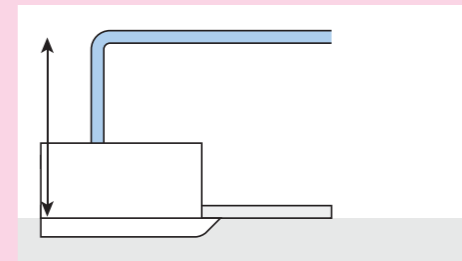

Note: With wireless remote controllers, one adjustment pocket is used to house the light receptor unit.



CEILING
SUSPENDED
CASSETTE TYPE

FUY Series
Cooling Only



R-22

Flexible and simple to install in any location.

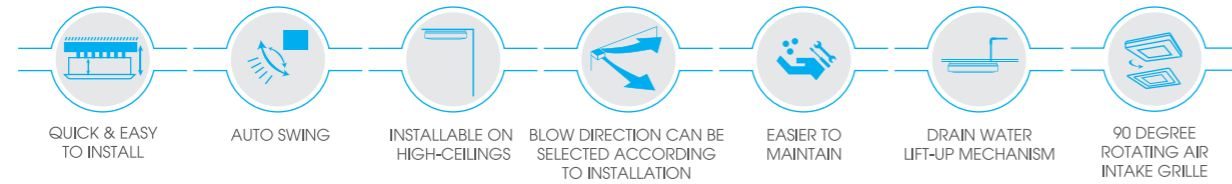

FUY71~125
COOLING ONLY

2.2 TR ~ 3.6 TR
(COOLING ONLY)

ACCESSORY REQUIRED FOR INDOOR UNIT

LCD WIRED REMOTE CONTROLLER

Standard



BRC1C61

LCD WIRELESS REMOTE CONTROLLER

Option



BRC7C529W



A light receptor must be added to the indoor unit.

Light receptor unit

Industry-top class noise attenuation

40/35 dB(A)
High Low

FUY71FJ

1 FEATURES

Feature	Comfort										Mildew Prevention	Work & Servicing			Control Features					Option	Others						
	Auto swing	Swing pattern selection	Draft prevention function	Switchable fan speed	Programme "Dry"	High ceiling application	Two selectable thermo-sensors	Hot start	Year-round cooling applicable	Timer selector	Mould resistant treatment for filter	Mildew-proofing drain pan	Drain water lift-up mechanism	Pre-charged for up to 30m	Filter sign	Low gas pressure detection	Emergency operation	Self-diagnosis function	Auto-restart	Auto-cooling/heating change-over	Control by 2 remote controllers	Control by 1 remote controller	External command control	Central remote control	Interlock control	Long-life Filter	PE fin
Cooling Only	•	•	—	•	•	•	• ¹	—	• ²	•	•	•	• ³	•	• ³	•	•	•	•	•	•	•	•	•	•	•	•

¹Applicable when wired remote controller is used ²Applicable to R71-125 outdoor units (for temp. down to -15°C) (An option is required) ³Applicable to R(Y)71-125 outdoor units

2 COMFORT

AUTO SWING

The auto swing function increases the comfort level.

AUTO SWING

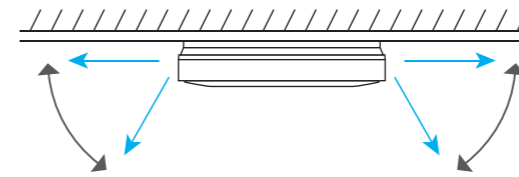

Auto swing between 0° and 60°.

5-LEVEL BLOW DIRECTIONTING

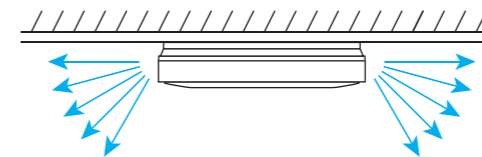

Settable to 5 different levels between 0° and 60°.

AUTO BLOW DIRECTION CONTROL

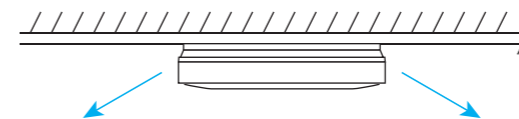

The last blow direction is saved in memory and automatically set the next time the unit is turned ON (Initial setting is 30° for cooling).

SWITCHABLE FAN SPEED: High/Low

PROGRAMME "DRY"

Computer-control dehumidifies room air without uncomfortably changing temperature too much.

INSTALLABLE ON HIGH CEILINGS

Criteria for ceiling height and number of blow outlets.

		Number of blow outlets used		
		2-way blow	3-way blow	4-way blow
Ceiling height	Standard	3.5 m	3.0 m	2.7 m
	High Ceiling (1)	3.8 m	3.3 m	3.0 m
	High Ceiling (2)	—	3.5 m	3.5 m

Note: Units are set to standard ceiling height and 4-way blow when shipped from the factory. High ceiling (1) and (2) are set from the remote controller.

BLOW DIRECTION CAN BE SELECTED ACCORDING TO INSTALLATION

Selection pattern for blow direction and fan speed ratio.

Note: Not applicable to setting of blow pattern other than the following.

Standard (100%) Moderate (approx. 70%) (*Requires sealing member of air discharge outlet (optional accessory) for opposing 2-way blow.)

2-way blow

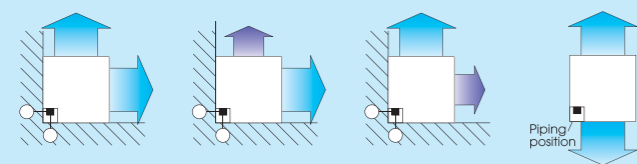
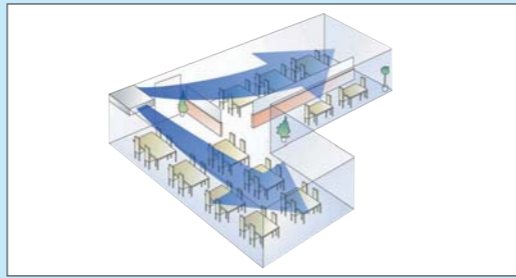
3-way blow

4-way blow

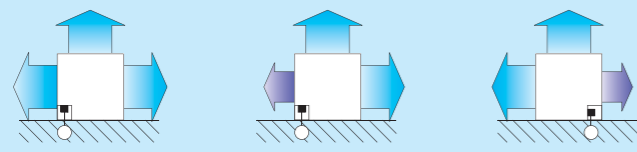
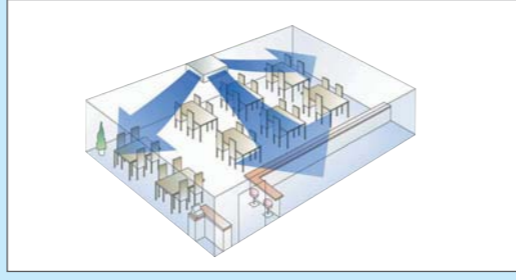
Note: When 2-way or 3-way blow installation is selected, the unused blow outlet(s) must be closed off, using the sealing material provided as a standard accessory. This will raise the operation noise by about 2dB.

EASIER TO MAINTAIN

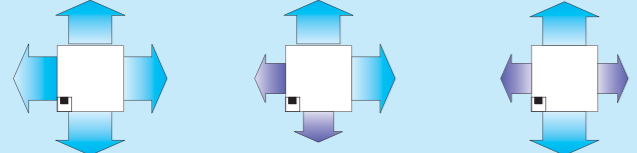
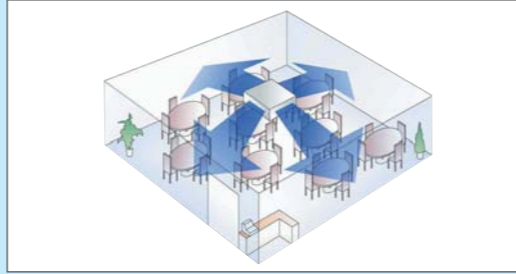
Accessible from the lower surface for easy maintenance. Low gas level detection function.

TWO SELECT THERMO-SENSORS

Thermo-sensors on both indoor unit and wired remote controller (optional). Temperature detection can be set closer to the living area to further improve comfort level.

Indoor unit's thermo-sensor must be used when the air conditioner is controlled from another room (Wireless remote controller does not have a thermo-sensor).

3 WORK & SERVICING

PROVIDED WITH HIGH LIFT DRAIN WATER LIFT-UP MECHANISM AS STANDARD EQUIPMENT IMPROVE COMFORT LEVEL.

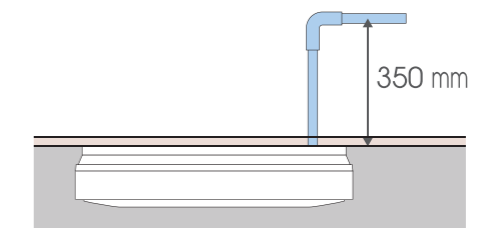

ULTRA-THIN WITH QUIET OPERATION

Made thinner and quieter, Daikin's proprietary technology has made it possible to achieve these previously contradictory characteristics.

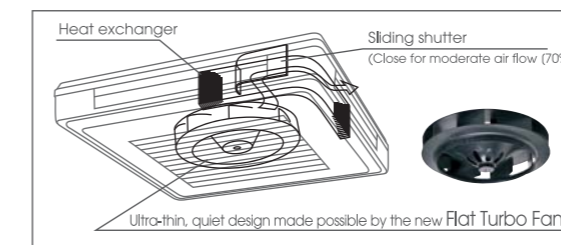

Indoor unit	High	Low
71	40dB	35dB
100	43dB	38dB
125	44dB	39dB

QUICK AND EASY TO INSTALL

Simple installation procedure
Simply lock the body in place with suspension bolts to install.
Adjustment is smooth & simple too.

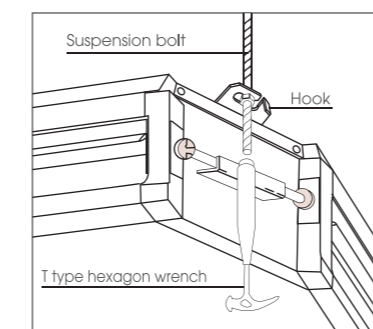

90° ROTATING AIR INTAKE GRILLE

Note: The panel cannot be turned when the wireless remote controller is in use. Contradictory characteristics.

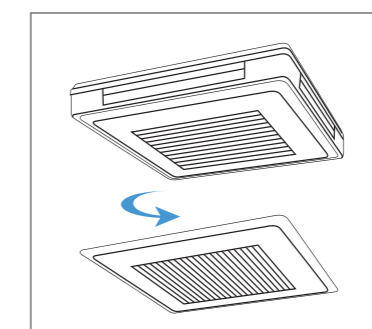



WALL
MOUNTED
TYPE

FAY Series
Cooling Only



R-22

Top class in the industry for compactness and silence. Wall mounted air conditioners demand this kind of performance.

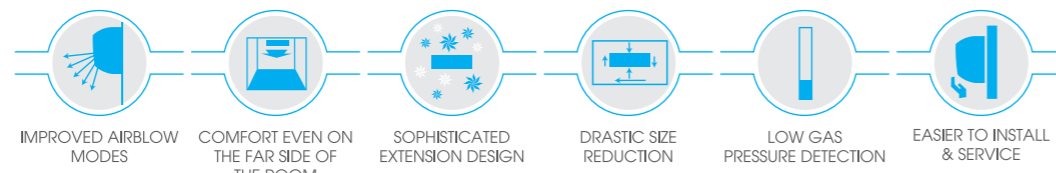

FAY71LVE/FAY100FAVE
(COOLING ONLY)

2.2 TR ~ 3 TR
(COOLING ONLY)

ACCESSORY REQUIRED FOR INDOOR UNIT

LCD WIRED REMOTE CONTROLLER

Standard



LCD WIRELESS REMOTE CONTROLLER

Option



A signal receiver must be added to the indoor unit.



Signal receiver unit (Installed type)



Top-class noise attenuation
43/37 dB
High Low

FAY71LVE

Top-class noise attenuation
45/41 dB
High Low

FAY100FAVE

2 COMFORT

IMPROVED AIR BLOW MODES ENSURE COMFORTABLE AIR DISTRIBUTION ACROSS THE ENTIRE ROOM.

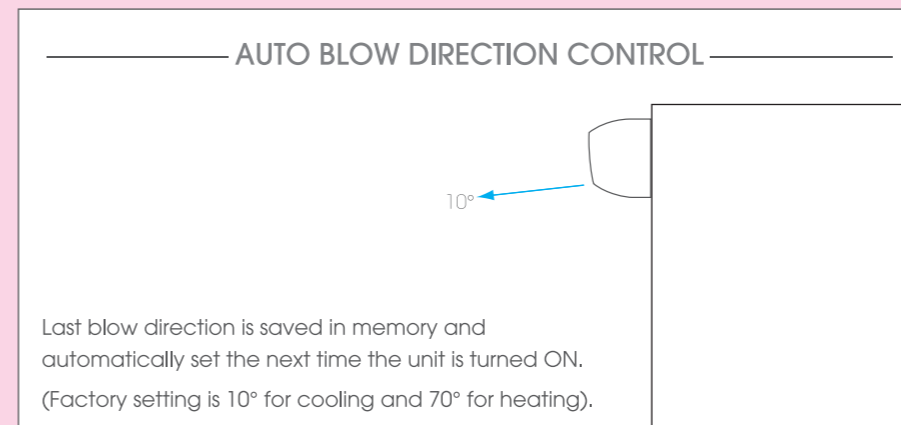
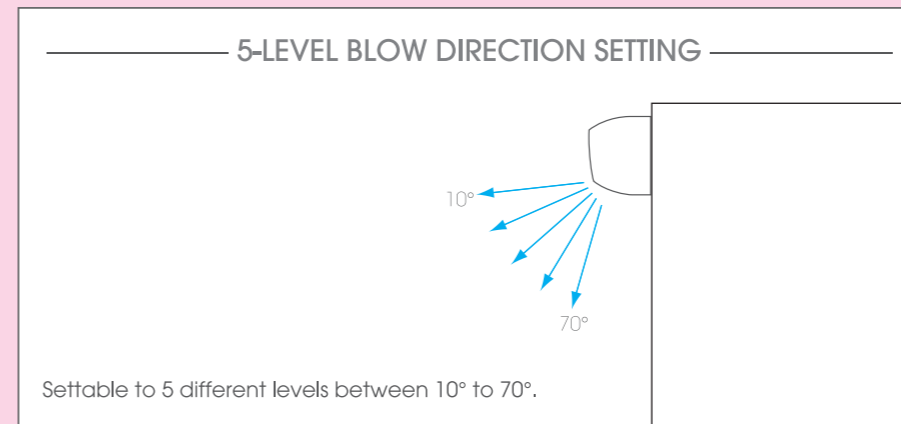
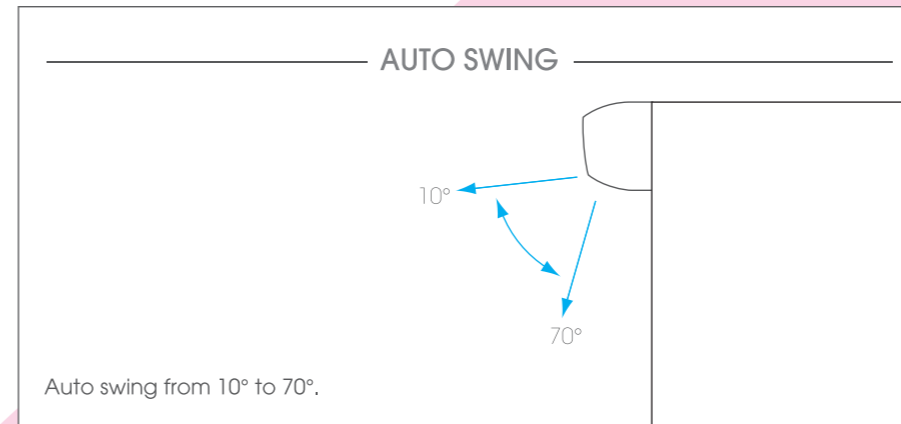

SWITCHABLE FAN SPEED: High/Low

PROGRAMME "DRY"

Dehumidification is computer controlled to prevent abrupt and uncomfortable changes in air temperature.

1 FEATURES

Feature	Comfort										Mildew Prevention	Work & Servicing					Control Features					Others				
	Auto swing	Draft prevention function	Switchable fan speed	Programme "Dry"	High fan speed mode	Two selectable thermo-sensors	Upward	Hot start	Year-round cooling applicable	Timer selector	Mould resistant treatment for filter	Mildew-proofing drain pan	Drain water lift-up mechanism	Pre-charged for up to 30m	Filter sign	Low gas pressure detection	Emergency operation	Self-diagnosis function	Auto-restart	Auto-cooling/heating change-over	Control by 2 remote controllers	Control by 1 remote controller	External command control	Central remote control	Interlock control	PE fin
Cooling Only	•	—	•	•	•	*1	•	—	*2	•	•	•	•	*3	•	*3	•	•	•	—	•	•	•	•	•	•

*1 Applicable when wired remote controller is used *2 Applicable to R71/R100 outdoor units (for temp. down to -15°C) (An option is required) *3 Applicable to R(Y)71/100 outdoor units

TWO SELECTABLE THERMO-SENSORS

Both indoor unit and wired remote controller (option) contain thermo-sensors. Temperature detection can be set at the unit or, to further improve comfort level, closer to the target area at the wired remote control.
Thermo-sensor on indoor unit must be used when the air conditioner is controlled from another room. (Wireless remote controller does not have a thermo-sensor).

COMFORT EVEN ON THE FAR SIDE OF THE ROOM

To carry air to the far side of long rooms, extra-high air blow adds 10% more fan speed to the "high" setting. Air blow strength is selected from the remote controller.

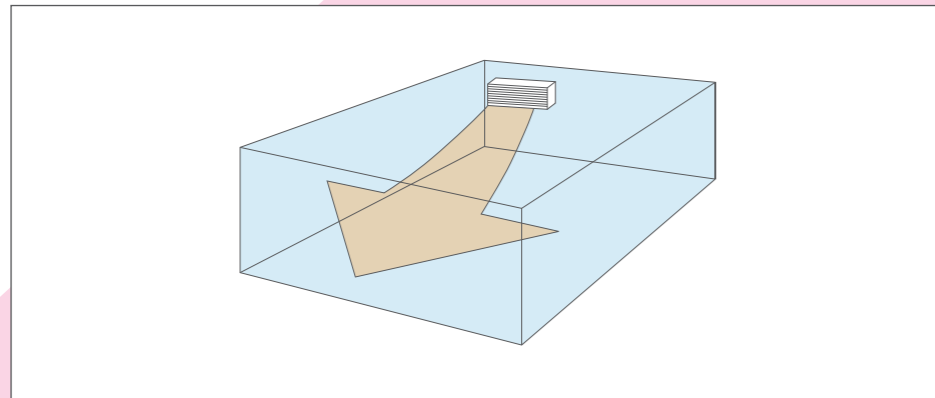

SOPHISTICATED EXTENSION DESIGN

Compact and stylish design that does not detract from the décor of the room.
Below features only apply to FAY71.

DRASTIC SIZE REDUCTION

Reduced size (by 22% in volume, 32% in installation area) makes installation possible in a very limited space.

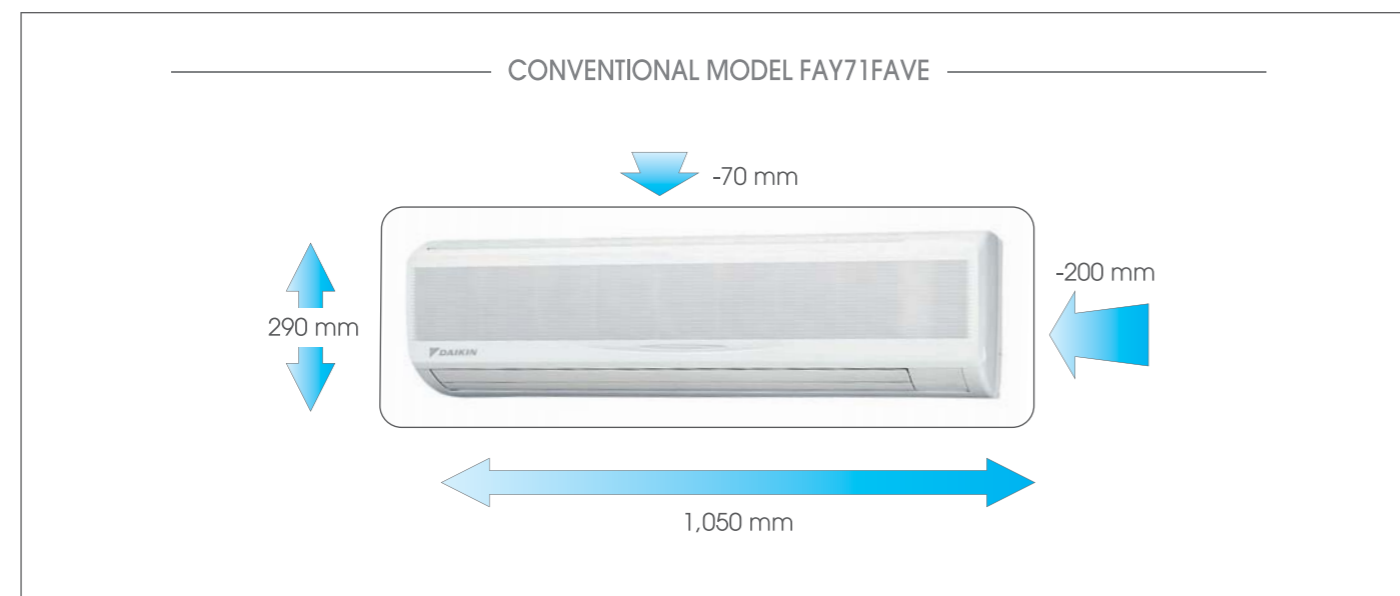

FLAP IS CLOSED WHEN NOT OPERATING

3 WORK & SERVICING

EASIER TO INSTALL AND SERVICE

Lightweight

Reduced weight by 8 kg greatly facilitates installation.

Conventional	New model
21 Kg	13 Kg

DRAIN PUMP KIT IS AVAILABLE AS OPTION

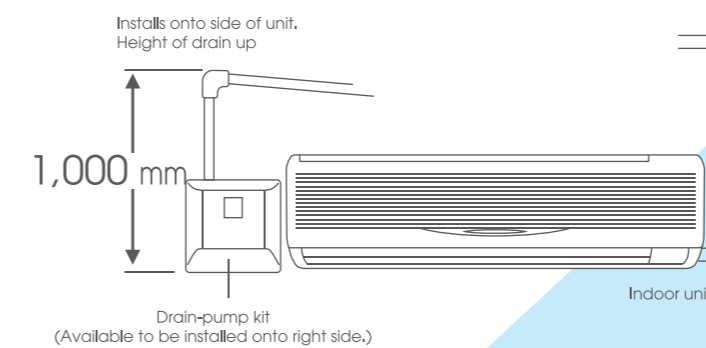

Drain enclosure can be used on either left or right side.
Drain pan and air filter can be kept clean by mildew-proof polystyrene.
Removable and washable grille DIII-NET connection is standard specification. Adapter is not required.

MAINTENANCE POSSIBLE FROM THE FRONT OF THE UNIT

All maintenance tasks can be carried out via front access. During service work, attachment and detachment of parts is easier.

LOW GAS PRESSURE DETECTION

Insufficient gas charging is normally hard to detect. During post-installation trials and regular inspection procedures, the refrigerant level is monitored by computer to ensure proper gas pressure.



CEILING SUSPENDED TYPE

FH/FHY Series
Cooling Only & Heat Pump



R-22

Upgrade to a quiet and compact system.

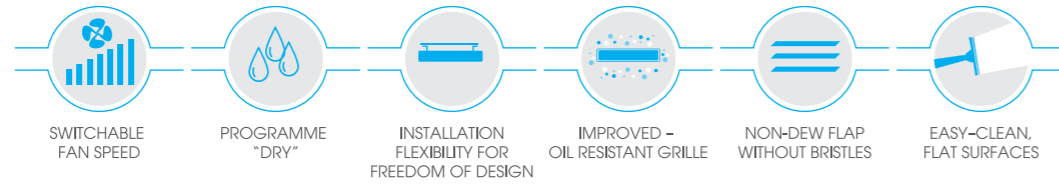

FH21NU~48NU (COOLING ONLY) FH50BVE~125BVE (HEAT PUMP) 1.8 TR ~ 4 TR (COOLING ONLY) 1.5 TR ~ 3.6 TR (HEAT PUMP)

ACCESSORY REQUIRED FOR INDOOR UNIT

LCD WIRED REMOTE CONTROLLER

Standard

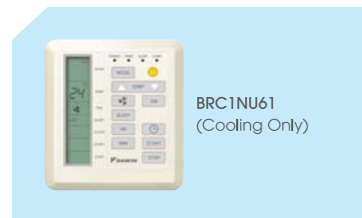

Note: Remote controller cable not included. Cables must be procured locally.

LCD WIRED REMOTE CONTROLLER

Standard

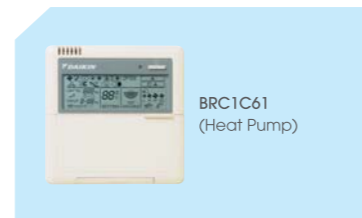

Note: Remote controller cable not included. Cables must be procured locally.

LCD WIRELESS REMOTE CONTROLLER

Option



A signal receiver must be added to the indoor unit.
BRC7NU66 (Cooling Only)

Signal receiver unit (Installed type)
Wireless remote controller and signal receiver unit are sold as a set.

Note: Wireless remote controller and signal receiver unit are sold as a set.

LCD WIRELESS REMOTE CONTROLLER

Option



A signal receiver must be added to the indoor unit.
BRC7E63W (Heat Pump)

Signal receiver unit (Installed type)

Note: Wireless remote controller and signal receiver unit are sold as a set.

1 FEATURES

Sound Level (Cooling Only) 44/40 dB(A) High Low
Sound Level (Heat Pump) 38/33 dB(A) High Low
FH21NUV1 FH50BVE

Feature	Comfort										Mould prevention	Work & Servicing				Control features				Option	Others							
	Auto swing	Draft prevention function	Switchable fan speed	Programme "Dry"	High ceiling application ¹⁾	Two selectable temperature-sensors	Hot start	Year-round cooling applicable	Timer selector	Mould resistant treatment ²⁾ for filter	Mould-proofing drain pan	Drain pump mechanism	Pre-charged for up to 15m	Pre-charged for up to 30m	Filter sign	Low gas pressure detection	Emergency operation	Self-diagnosis function	Auto-restart	Auto-cooling/heating change-over	Control by 2 remote controllers	Control by 1 remote controller	External command control	Central remote control	Interlock control	Long-life filter	Twin / triple / double twin multi-operation	PE fin
Model	•	•	•	•	•	•	•	•	•	•	•	•	•	•	•	•	•	•	•	•	•	•	•	•	•	•	•	•
Cooling Only	•	•	•	•	•	•	•	•	•	•	•	•	•	•	•	•	•	•	•	•	•	•	•	•	•	•	•	•
Heat Pump	•	•	•	•	•	• ²⁾	•	• ⁴⁾	•	•	•	•	•	•	•	•	•	•	•	•	•	•	•	•	•	•	•	•

¹⁾Installable on max. 3.5 m high ceiling ²⁾Applicable when wired remote controller is used ³⁾Applicable to R71LU-R140LU outdoor units (for temp. down to -15°C) (An option is required.)
⁴⁾Applicable to RY71LU-RY140LU outdoor units (for temp. down to -5°C) and RY200LU-RY250LU outdoor units (for temp. down to -0°C) ⁵⁾Optional available
⁶⁾Applicable to R(Y)71LU-140LU outdoor units

2 COMFORT

SPREADS COMFORTABLE AIR THROUGHOUT THE ROOM

Auto-swing (up & down) brings comfort to the room.

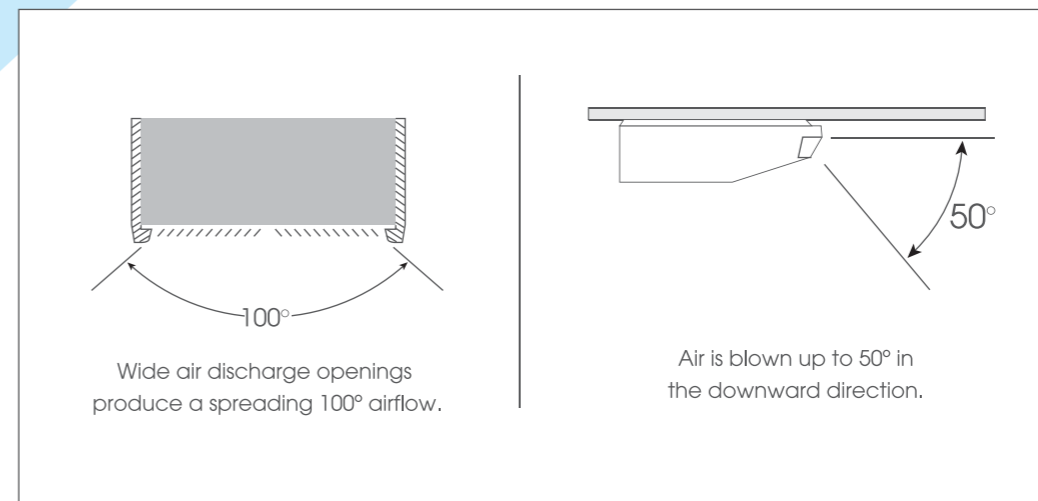

SWITCHABLE FAN SPEED: High/Middle/Low

PROGRAMME "DRY"

Dehumidification is microprocessor controlled to prevent abrupt and uncomfortable changes in air temperature.

HIGH CEILING APPLICATION

Installable on ceilings 3.5 m high.

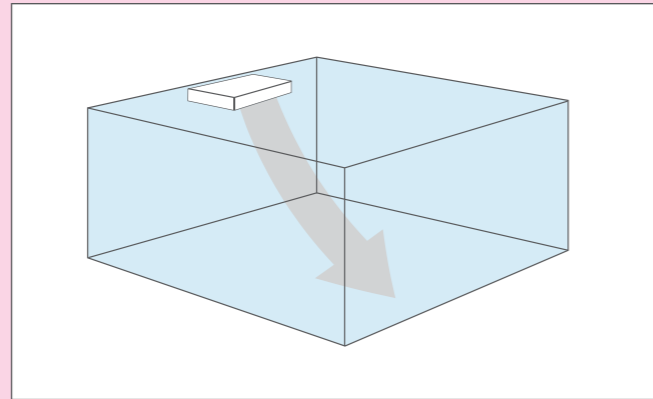

EASIER TO MAINTAIN

Long-life filter lasts about half year; maintenance not required.
For dust concentration of 0.15 mg/m³.

QUIET OPERATION

Sound operation has been reduced on the exposed ceiling suspended type unit.

(Cooling Only)			(Heat Pump)		
Indoor unit	High	Low	Indoor unit	High	Low
21NU	44	40	50B	38	33
26NU	44	40	60B	38	33
30NU	45	40	71B	39	35
36NU	46	40	100B	42	37
42NU	48	42	125B	44	39
48NU	49	43			

Note: Anechoic chamber conversion value, measured according to JIS parameters and criteria.

Note: Anechoic chamber conversion value, measured according to JIS parameters and criteria.

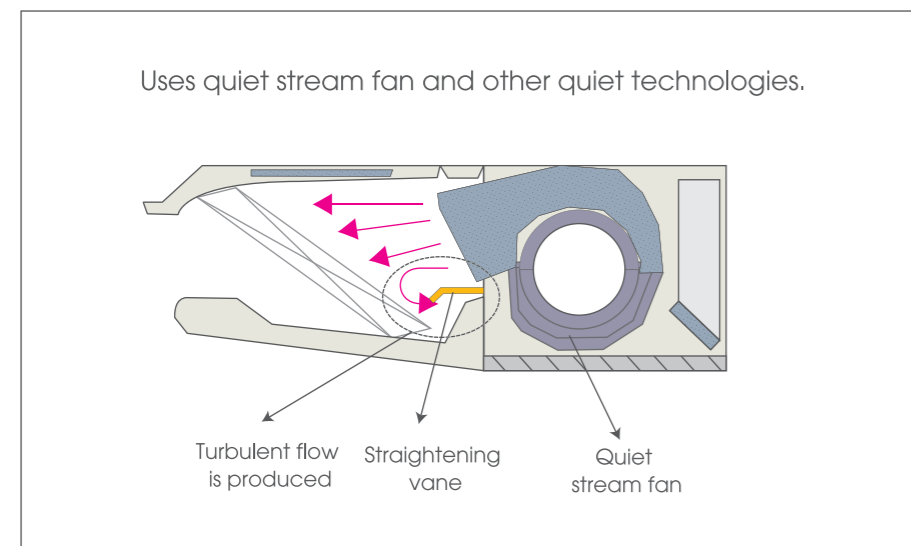

3 WORK & SERVICING

INSTALLATION FLEXIBILITY FOR FREEDOM OF DESIGN

- Uniform height and depth. Compact design for small-capacity models to meet tighter dimensional constraints.

Indoor Unit	50 B	60/70 B 21/26 NU	100 B 30 NU	125 B 36/42/48 NU
Height	195			
Width	960	1160	1400	1590
Depth	680			

- Reduced edge space, flexible installation.
- The unit fits more snugly into tight spaces.

For 48NU indoor unit

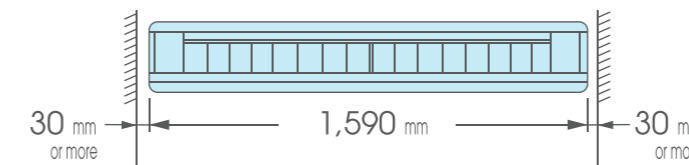

Water used in the test-run can now be drained from the air discharge opening rather than from the side as was formerly the case.

- All wiring and internal servicing done from below the unit.
- Pipes more easily rigged, too.
- Plastic panels are used to conceal piping holes. Holes can be easily punched out without requiring special tools.

IMPROVED-OIL RESISTANT GRILLE

Oil-resistant plastic is used for the air discharge grille. This improves durability in restaurants and other similar environments.
Note: Intended for use in salons, dining rooms, and ordinary sales floors, this specification is not suitable for kitchens or other harsh environments.

NON-DEW FLAP WITHOUT BRISTLES

Absence of bristles minimises clinging dirt and simplifies cleaning.

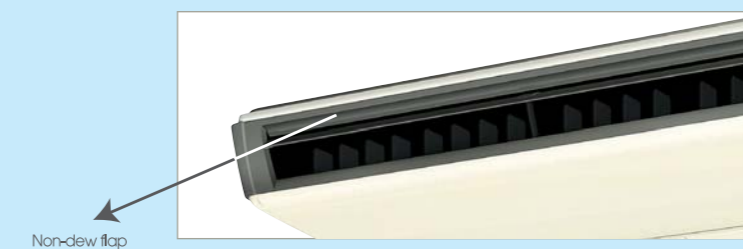

EASY-CLEAN, FLAT SURFACES

It is easy to wipe dirt off the flat side and lower surfaces of the unit.

FOR ALL MAINTENANCE TASKS, ACCESS IS FROM BOTTOM SURFACE

REDUCED INSTALLATION TIME



FLOOR STANDING TYPE

FVY Series
Cooling Only

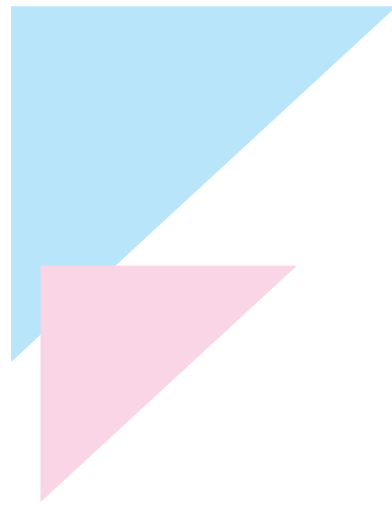

R-22

The floor-standing configuration means the FVY is easy to install and maintain. It can also be installed under high ceilings.

HIGHEST CLASS OF NOISE EMISSION CONTROL IN THE INDUSTRY

EASY TO OPERATE. HANDY LCD CONTROL PANEL

SWITCHABLE FAN SPEED

PROGRAMME "DRY"

FVY71~125
(COOLING ONLY)

2.2 TR ~3.6 TR
(COOLING ONLY)

LCD CONTROL PANEL AS STANDARD EQUIPMENT

Option



BRC1C61

1 FEATURES

Industry-top class noise attenuation
41/35dB
High Low

FVY71LAVE

Feature	Comfort						Mildew Prevention	Work & Servicing			Control Features					Option	Other					
	Auto swing	Switchable fan speed	Programme "Dry"	Hot start	Two selectable thermo-sensors	Year-round cooling applicable	Timer selector	Mould resistant treatment for filter	Pre-charged for up to 30m	Filter sign	Low gas pressure detection	Emergency operation	Self-diagnosis function	Auto-restart	Auto-cooling/heating change-over	Control by 2 remote controllers	Control by 1 remote controller	External command control	Central remote control	Interlock control	Long-life filter	PE fin
Cooling Only	•	•	•	—	•	*1	•	•	*2	•	*2	•	•	•	—	•	•	•	•	•	•	•

*1Applicable to R71-R125 outdoor units (for temp. down to -15°C) (An option is required) *2Applicable to R(Y)71-125 outdoor units

2 COMFORT

AUTO SWING DELIVERS COMFORT TO EVERY CORNER OF THE ROOM

The FVY incorporates a built-in swinging louvre that horizontally distributes a comfortable air blow. It moves slowly at a speed of 2 to 3 full strokes per minute, thus preventing any sensation of sudden drafts.

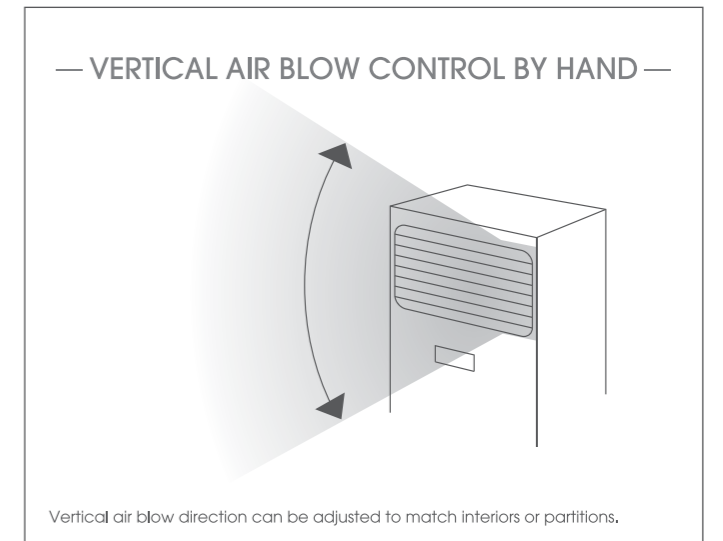
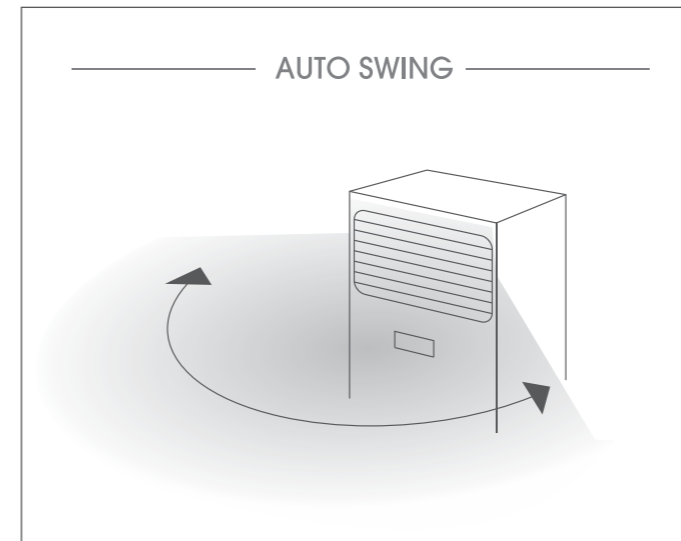

SWITCHABLE FAN SPEED: High/Low

PROGRAMME "DRY"

Computer-control dehumidifies room air without uncomfortably changing the temperature too much.

HIGHEST CLASS OF NOISE EMISSION CONTROL IN THE INDUSTRY

Open installation demands that this floor standing air conditioner tops in the industry in silent running performance.

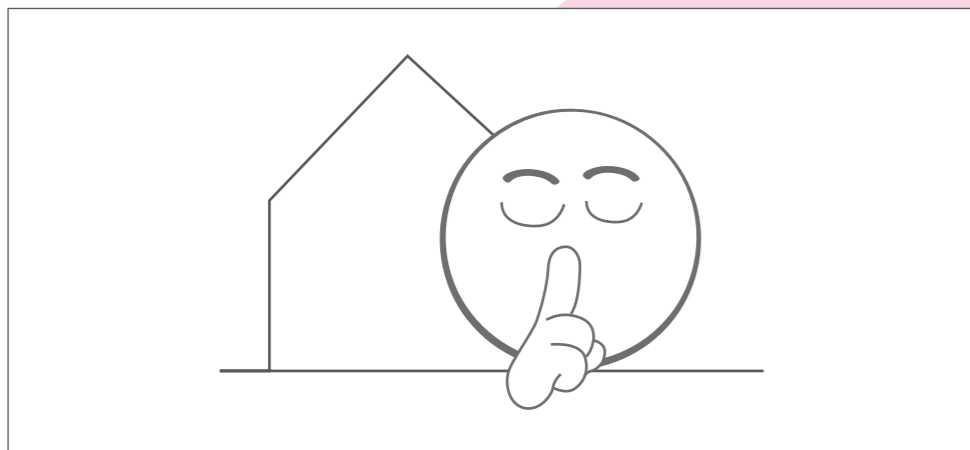

Indoor unit	High	Low
71	41dB	35dB
100	46dB	40dB
125	49dB	43dB

LOW GAS LEVEL DETECTION FUNCTION

A computer monitors the refrigerant level to detect low gas charge during the post-installation test-runs and other inspections, which is normally difficult to discover.

INSTALLABLE UNDERNEATH HIGH CEILINGS

Note: Accurate calculations required for proper installation.

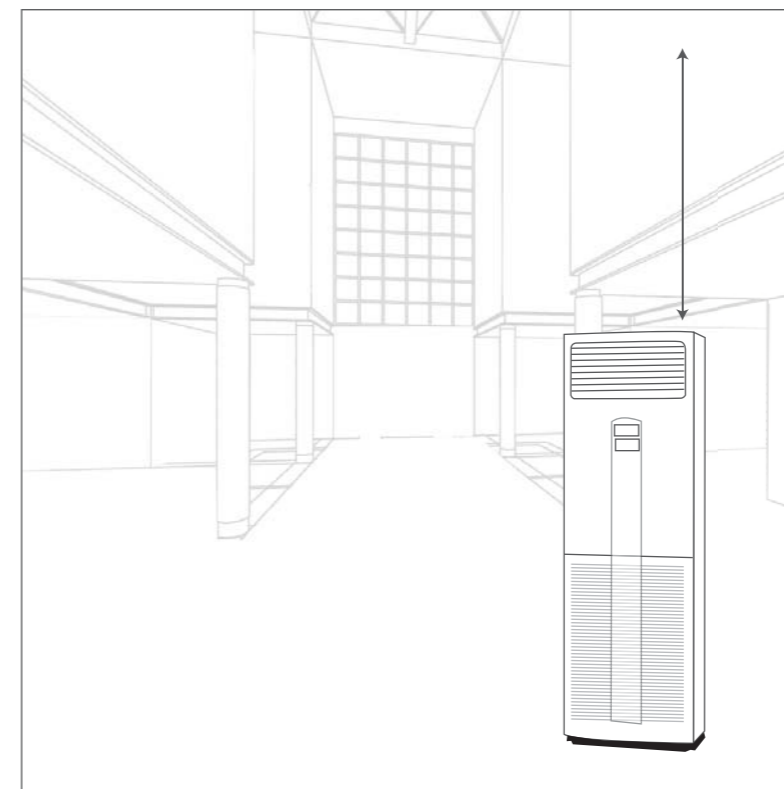

3 WORK & SERVICING

EASIER TO INSTALL AND SERVICE

One of the lightest weight floor standing units in the industry. Lightweight, the unit can be easily transported and installed.

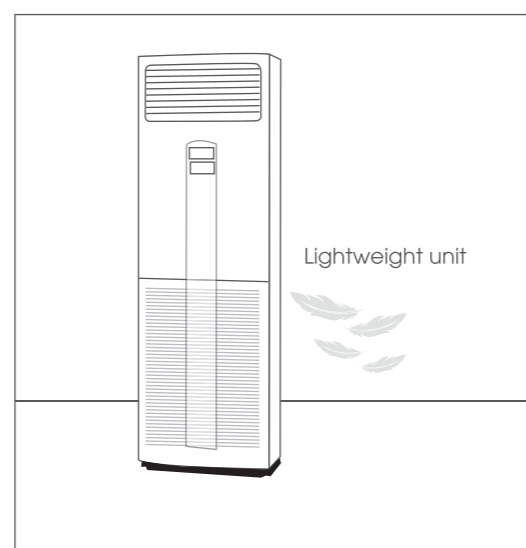

4 CONTROL FEATURES

EASY TO OPERATE, HANDY LCD CONTROL PANEL

The LCD displays text, numbers and graphics to indicate the temperature setting, timer setting, auto swing, fan speed and more. Furthermore, the panel can be detached and used as a remote controller, so airconditioning can be controlled from another room or the cash register (Remote controller cable not included, cables must be procured in the field).

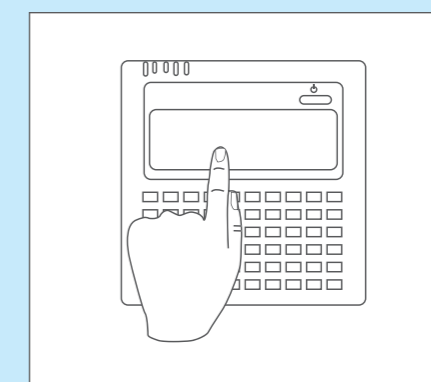



DUCT
CONNECTION
LOW STATIC
PRESSURE TYPE

FDB/FDYB Series
Cooling Only & Heat Pump



Ideal for quiet, beautiful living spaces.
Suitable for condominiums and apartments, houses and hotels.

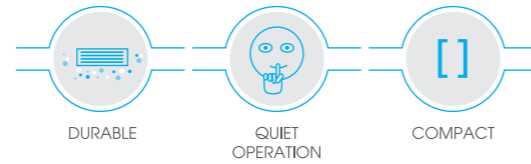

FDB25~71KVE (COOLING ONLY) **FDYB35~71KAVE** (HEAT PUMP) **0.7 TR ~ 2.2 TR** (COOLING ONLY) **1 TR ~ 2.2 TR** (HEAT PUMP)

DIGITAL REMOTE CONTROLLER

Standard

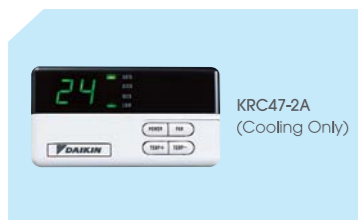

KRC47-2A
(Cooling Only)

WIRED LCD REMOTE CONTROLLER

Standard

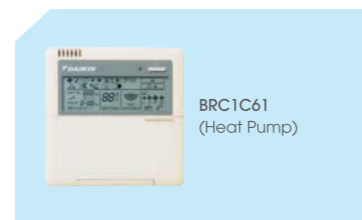

BRC1C61
(Heat Pump)

Note: Remote controller cable not included. Cables must be procured locally.

REMOTE CONTROLLER

Option

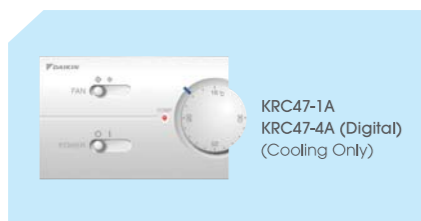

KRC47-1A
KRC47-4A (Digital)
(Cooling Only)

WIRELESS LCD REMOTE CONTROLLER

Option

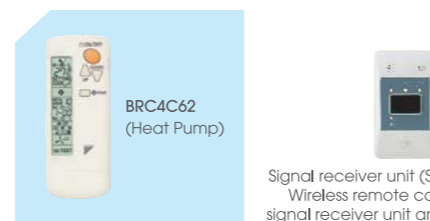

BRC4C62
(Heat Pump)

Signal receiver unit (Separate type)
Wireless remote controller and
signal receiver unit are sold as a set.

1 FEATURES

Sound Level (Cooling Only) **41/38** dB(A) High Low
Sound Level (Heat Pump) **41/38** dB(A) High Low
FDB25/35/50KVE FDYB35/50KAVE

Feature	Comfort					Work & Servicing					Control Features					Others				
	Switchable fan speed	Programme "Dry"	Hot start	Automatic cool/heat change-over	Year-round cooling applicable	Timer selector	Pre-charged for up to 30m	Pre-charged for up to 10m	Low gas pressure detection	Emergency operation	Self-diagnosis function	Auto-restart	Control by 2 remote controllers	Group control by 1 remote controller	External command control	Central remote control	Interlock control	Triple and double twin multi operation	PE fin	Adjustable external static pressure
Model	•	•	•	•	•	•	•	•	•	•	•	•	•	•	•	•	•	•	•	•
Cooling Only	•	—	—	—	—	—	—	—	—	—	•	—	—	—	—	—	—	—	—	•
Heat Pump	•	•	•	•	*1	•	*2	—	*2	•	•	•	•	•	•	•	•	•	•	•

*1 Applicable to R36NU~R51NU outdoor units

2 COMFORT

QUIET OPERATION

(Cooling Only)	(220V) dB(A)		(Heat Pump)	(220V) dB(A)	
	Indoor unit	High		Low	Indoor unit
FDB25KVE	41	38	FDYB35KAVE	41	38
FDB35KVE	41	38	FDYB50KAVE	41	38
FDB50KVE	41	38	FDYB60KAVE	43	40
FDB60KVE	43	40	FDYB71KAVE	43	40
FDB71KVE	43	40			

Note: Anechoic chamber conversion value, measured according to JIS parameters and criteria.

3 WORK & SERVICING

DURABLE

To achieve increased durability and improved resistance to salt corrosion and atmospheric pollution, coated PE fins (with special acryl pretreatment) are used for the heat exchanger of the outdoor unit.

COMPACT

Small, lightweight, and easy-to-install outdoor unit.

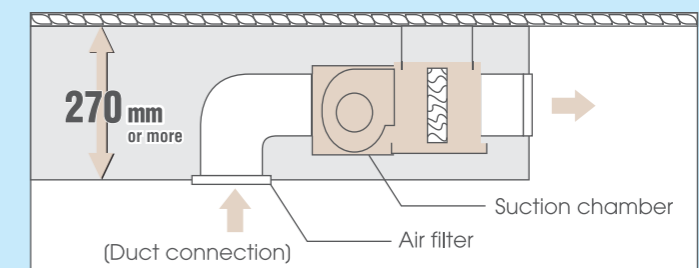

To prevent increased operation sound, avoid installing the air suction grille directly below the suction chamber.



DUCT
CONNECTION
MIDDLE STATIC
PRESSURE TYPE

FDMG/FDYM Series
Cooling Only & Heat Pump

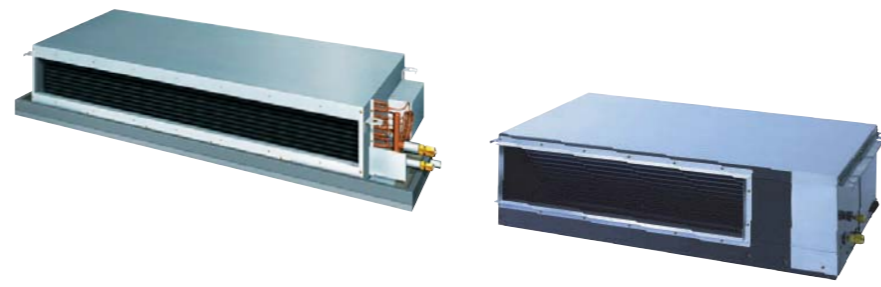

R-22

Unit can be mounted in the ceiling and air can be delivered freely by duct.



FDMG26~56NU (COOLING ONLY) FDYM03FAV1~06FAV1 (HEAT PUMP)

2.2 TR ~ 4.6 TR (COOLING ONLY)
2.2 TR ~ 4 TR (HEAT PUMP)

REMOTE CONTROLLER

Standard

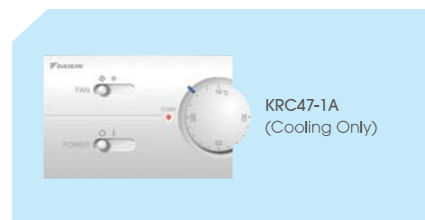

WIRED LCD REMOTE CONTROLLER

Standard

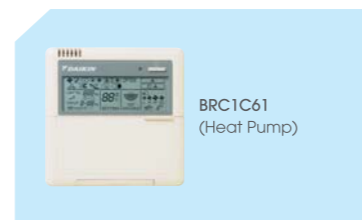

Note: Remote controller cable not included. Cables must be procured locally.

DIGITAL REMOTE CONTROLLER

Option

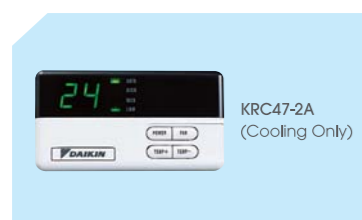

WIRELESS LCD REMOTE CONTROLLER

Option



1 FEATURES

Feature	Comfort					Work & Servicing				Control Features				Others						
	Switchable fan speed	Programme "Dry"	Hot start	Automatic cool/heat change-over	Year-round cooling applicable	Timer selector	Pre-charged for up to 30m	Low gas pressure detection	Emergency operation	Self-diagnosis function	Pre-charged for upto 15m	Auto-restart	Control by 2 remote controllers	Group control by 1 remote controller	External command control	Central remote control	Interlock control	Triple and double twin multi operation	PE fin	Adjustable external static pressure
Model																				
Cooling Only	•	—	—	—	—	—	—	—	—	—	•	—	—	—	—	—	—	•	•	
Heat Pump	•	•	•	•	*2	•	*3	*3	•	•	—	•	•	•	•	•	•	•	•	

*2Applicable to RY71LU-RY140LU outdoor units (for temp. down to -5° C) *3Applicable to R(Y)71LU-140LU outdoor units

Sound Level (Cooling Only)
44/36 dB(A)
High Low
FDMG30NUV1

Sound Level (Heat Pump)
39 dB(A)
High
FDYM03/04FAV1

2 COMFORT

SWITCHABLE FAN SPEED: High/Middle/Low

Drain pipe connection can be done inside the unit. Coolant and drain pipe outlets are at the same opening.

QUIET OPERATION

(Cooling Only)

Sound Level (220V) dB(A)

(Heat Pump)

Indoor unit	Capacity (Ton)	High	Low
FDMG26NU	2.2	42	38
FDMG30NU	2.5	44	36
FDMG36NU	3.0	45	37
FDMG42NU	3.6	46	37
FDMG48NU	4.0	46	37
FDMG51NU	4.2	47	37
FDMG56NU	4.6	47	37

Indoor unit	Sound Level
FDYM03FA	39
FDYM04FA	39
FDYM05FA	44
FDYM06FA	46

Note: Anechoic chamber conversion value, measured according to JIS parameters

SIMULTANEOUS AIRCONDITIONING OF TWO ROOMS AND VENTILATION GRILLE (VENTILATION OPENING)

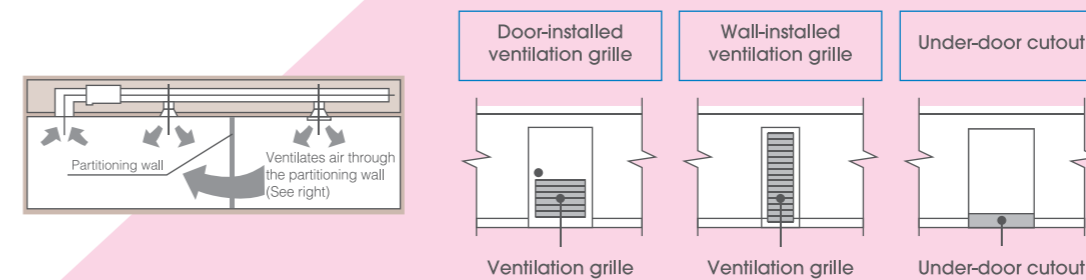

Note: The under-door cutout method should be used only when there is a small volume of airflow.

When airconditioning two rooms simultaneously, the air discharged into each room must be circulated back to the air conditioner. To achieve this, a ventilation duct should be installed for each room or one of the indicated ventilation grilles should be installed on the partitioning wall or under the door between the rooms.

SUPERIOR FREEDOM OF LAYOUT

- The duct system allows the efficient location of discharge outlets in accordance with the room layout.
- Middle static pressure type usable in a larger than standard space.
- Duct connection is simpler with standard rear intake chambers.

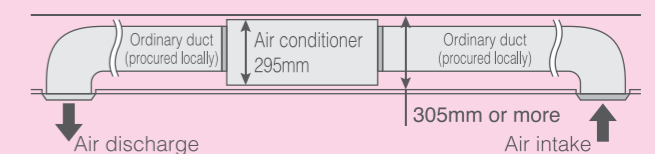



COMPACT
MULTI FLOW
CEILING MOUNTED
CASSETTE TYPE

FFQ Series
Cooling Only & Heat Pump



R-410A

Quiet, décor-blending form and easy installation in new or old buildings.

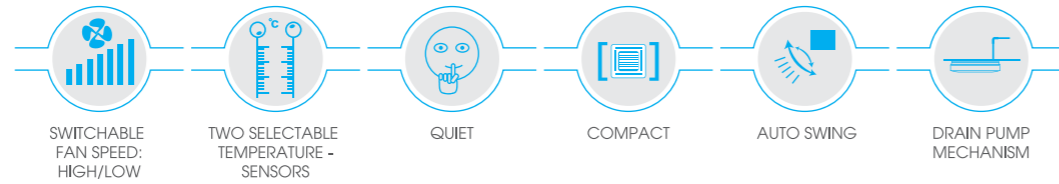

FFQ25B~60B
(COOLING ONLY/HEAT PUMP)

0.7 TR ~ 1.8 TR
(COOLING ONLY/HEAT PUMP)

WIRED LCD REMOTE CONTROLLER WITH WEEKLY SCHEDULE TIMER

Standard

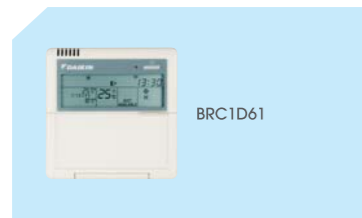

Note: Standard for both Cooling Only and Heat Pump models. Remote controller cable not included. Cables must be procured locally.

WIRED LCD REMOTE CONTROLLER

Option

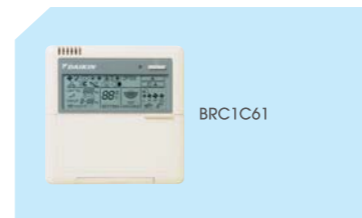

Note: Remote controller cable not included. Cables must be procured locally.

WIRELESS LCD REMOTE CONTROLLER

Option



A signal receiver must be added to the indoor unit.
BRC7E531W (Cooling Only)
BRC7E530W (Heat Pump)



Signal receiver unit (Installed type)

Wireless remote controller and signal receiver unit are sold as a set.

NAVIGATION REMOTE CONTROLLER (H/P)

Option

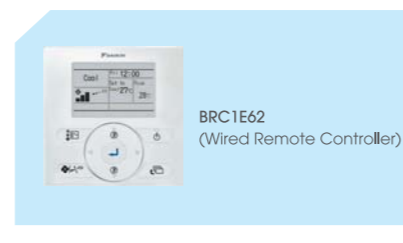

BRC1E62
(Wired Remote Controller)

Note: Remote controller cable not included. Cables must be procured locally.

1 FEATURES

Sound Level
29.5/24.5 dB(A)
High Low
FFQ25B/1B

Feature	Comfort										Mould Prevention	Work & Servicing			Control features				Option		Others				
	Auto swing	Swing pattern selection	Draft prevention function	Switchable fan speed	Programme "Dry"	Two selectable temperature-sensors	Hot start	Years-round cooling applicable	Timer selector	Mould-resistant treatment for filter		Drain pump mechanism	Pre-charged for up to 10m	Filter sign	Emergency operation	Self-diagnosis function	Auto-restart	Auto-cooling/heating change-over	Control by 2 remote controllers	Control by 1 remote controller		External command control	Central remote control	Interlock control	Fresh air intake kit
Model	•	•	•	•	•	•	•	•	•	•	•	•	•	•	•	•	•	•	•	•	•	•	•	•	•
Cooling Only	•	•	•	•	•	•	•	•	•	•	•	•	•	•	•	•	•	•	•	•	•	•	•	•	•
Heat Pump	•	•	•	•	•	•	•	•	•	•	•	•	•	•	•	•	•	•	•	•	•	•	•	•	•

*1 Applicable when wired remote controller is used

2 COMFORT

AUTO SWING & DRAFT PREVENTION FUNCTION

- Designed for low draft performance.
- Consistent comfort throughout.
- Auto-swing operation distributes conditioned air more evenly.
- Airflow angle can be adjusted in accordance with room conditions.



	AUTO-SWING	5-LEVELS AIR DIRECTION SETTING
Standard setting	Auto-swing between 0° and 60°	Settable to 5 different levels between 0° and 60°
Draft prevention setting (Set on site)	Auto-swing between 0° and 35°	Settable to 5 different levels between 0° and 35°
Setting to prevent soiling of ceiling (Set on site)	Auto-swing 60° between 25° and 60°	Settable to 5 different levels between 25° and 60°

Note: This angle above is provided as a guide. It may differ depending on the installation site.

SWITCHABLE FAN SPEED: High/Low

High setting provides maximum reach while low setting minimizes drafts.

TWO SELECTABLE TEMPERATURE-SENSORS

Both indoor unit and wired remote controller (option-BRC1E62) contain temperature-sensors. Temperature sensing can be set at the unit or, to further improve comfort level, closer to the target area at the wired remote control. This feature requires initial setting by the installer.

Temperature-sensor on indoor unit must be used when the air conditioner is controlled from another room.
Wireless remote controller does not have a temperature-sensor.

HOT START (AFTER DEFROST)

Uncomfortable cold air draft is avoided when heating operation starts or when switching to heat after defrosting.

QUIET

Quiet, small-diameter fan.

Quiet operation has been achieved even with a compact body and developed spiral hub cover that reduces the static pressure inside the indoor unit.

AIR DIRECTION CAN BE SELECTED ACCORDING TO INSTALLATION

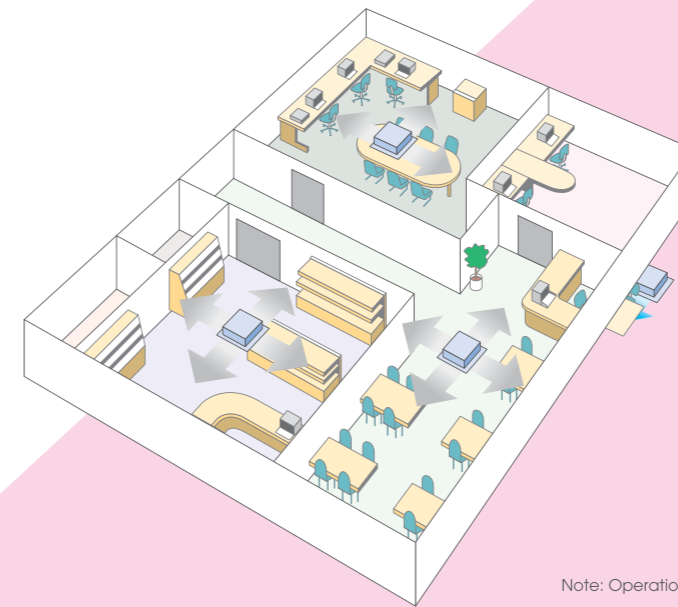

Note: Operation sound increases when using 2-way or 3-way flow.

3 WORK & SERVICING

DRAIN PUMP MECHANISM

Drain pump is equipped as standard accessory with 750 mm lift.

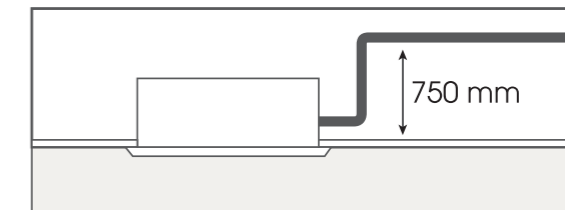

COMPACT

Sized to fit inside 600 mm wide ceiling grids.

Fits without the need to cut T-bar grid.

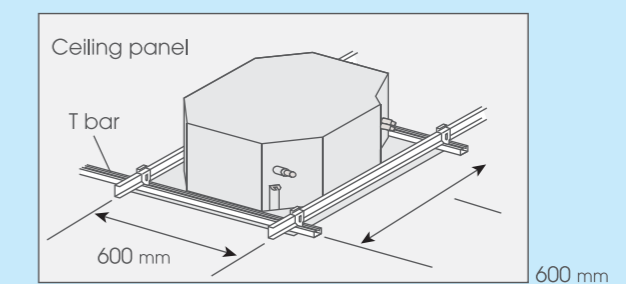
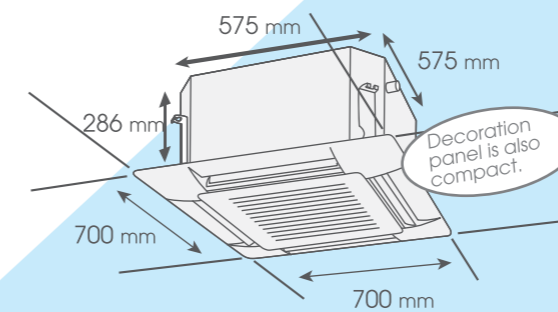

MULTI-FLOW SYSTEM

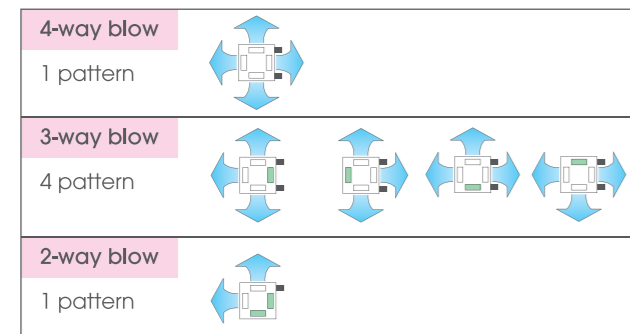

■ denotes piping direction.
 ■ Drain piping
 ■ denotes sealing member for air discharge outlet (option).

Note: For 3-way or 2-way flow installation, the sealing member for air discharge outlet (option) must be used to close off the unused outlet(s).

The switch box is built in to the unit, so maintenance is possible by simply removing the grill. An inspection opening is not required even for modules other than 600 mm x 600 mm.





ROUND FLOW
CEILING MOUNTED
CASSETTE TYPE

FCQ Series
Cooling Only & Heat Pump



INVERTER

R-410A

ROUND FLOW

Uniform 360° airflow cassette air conditioner is setting tomorrow's standards.

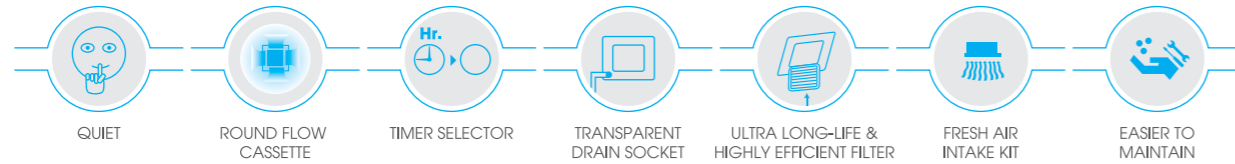

FCQ50~140 (COOLING ONLY) **FCQ71~140** (HEAT PUMP) **1.5 TR ~ 4 TR** (COOLING ONLY)
2.2 TR ~ 4 TR (HEAT PUMP)

ACCESSORY REQUIRED FOR INDOOR UNIT

WIRED LCD REMOTE CONTROLLER

Standard



BRC1C61
(Cooling Only)

Note: Remote controller cable not included. Cables must be procured locally.

WIRED LCD REMOTE CONTROLLER WITH WEEKLY SCHEDULE TIMER

Standard

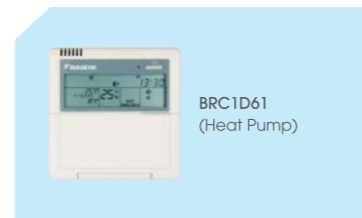

BRC1D61
(Heat Pump)

Note: Remote controller cable not included. Cables must be procured locally.

WIRELESS LCD REMOTE CONTROLLER

Option



BRC7F633F (Cooling Only)
BRC7F632F (Heat Pump)



Signal receiver unit (Installed type)

Wireless remote controller and signal receiver unit are sold as a set.

NAVIGATION REMOTE CONTROLLER

Option

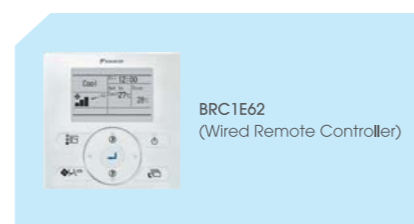

BRC1E62
(Wired Remote Controller)

Note: Remote controller cable not included. Cables must be procured locally.

1 FEATURES

Sound Level
35/28 dB(A)
 High Low
 FCQ50LUV1/FCQ71LUV1

Feature	Comfort						Cleanliness		Work & Servicing				Control features				Options		Others															
	Auto swing	Swing pattern selection	Draft prevention function	Switchable fan speed (2 step)	Programme "Dry"	High ceiling application	Two selectable temperature-sensors	Hot start (after defrost) applicable	Year-round cooling	Night quiet operation	Timer selector	Weekly schedule timer	Anti-bacterial air filter	Silver ion anti-bacterial drain pan	Drain pump mechanism	Pre-charged for up to 30 m	Long-life filter	Filter sign	Ceiling soiling prevention	Low gas pressure deflection	Emergency operation	Self-diagnosis function	Auto-restart	Auto-cooling/heating change-over	Control by 2 remote controllers	Group control by 1 remote controller	External command control	Central remote control	Interlock control	High-efficiency filter	Ultra long-life filter	Fresh air intake kit	Anti corrosion treated heat exchangers	
Cooling Only	•	•	—	•	•	•	+1	—	—	+2	•	+3	•	•	•	+2	•	•	•	•	•	•	•	•	•	•	•	•	•	•	•	•	•	+2
Heat Pump	•	•	•	•	•	•	+1	•	•	+2	•	+3	•	•	•	+2	•	•	•	•	•	•	•	•	•	•	•	•	•	•	•	•	•	+2

*1 Applicable when wired remote controller is used; *2 For outdoor units; *3 Applicable when BRC1D61 or BRC1E62 is used.

2 COMFORT

ROUND FLOW CASSETTE



• Comfortable airflow
 360° airflow with improved temperature distribution.

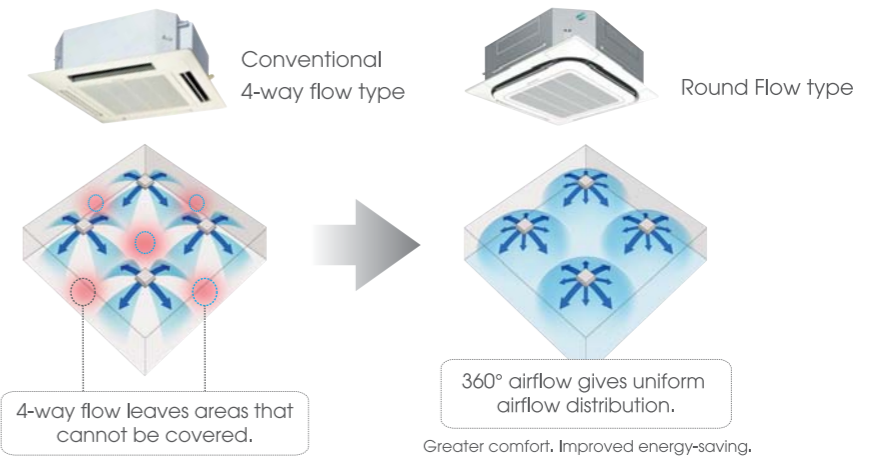
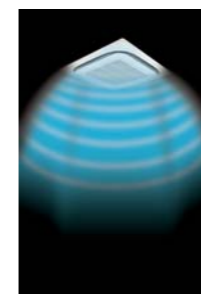

AVOIDS NON-UNIFORM TEMPERATURE AND DISCOMFORT CAUSED BY DRAFTS

Comfort enhanced by Round Flow!
 With uniform temperature distribution
 • 360° airflow

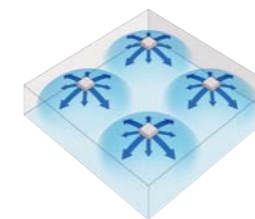

Greater comfort
 Improved energy-saving.

Air movement is gentle with Round Flow





Enhanced Comfort
 360° airflow can maintain comfort even if air discharge speed is lower.

If you raise the set temperature by 1 to 1.5°C, and velocity is decreased by 25%, you still obtain the same temperature and comfort.

OPTIMAL COMFORT AND CONVENIENCE ASSURED BY AIR DISCHARGE MODES

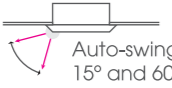
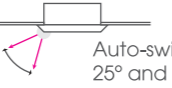
Note Air direction is set to the standard position when the unit is shipped from the factory. The position can be changed from the remote controller.

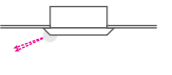
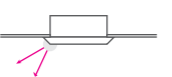
Blow direction	Standard setting	Setting to prevent soiling of ceiling*
Desired situation	Standard position to prevent draft.	Recommended for shops with light coloured ceilings that must be kept spotless.
Auto-swing	 Auto-swing between 15° and 60°	 Auto-swing between 25° and 60°
Blow direction can be set to 5 levels	 Settable to 5 different levels between 15° and 60°	 Settable to 5 different levels between 25° and 60°
Draft prevention (In heating mode)	 At heating startup and thermo OFF, air discharge is automatically set to a near horizontal 25° or 30° to prevent direct exposure to cool air drafts.	
Auto blow direction control	 The last discharge direction is saved in memory and automatically set the next time the unit is turned ON.	

*Closing of the corner discharge outlets is recommended.

SUITABLE FOR HIGH CEILINGS

Even in spaces with high ceilings, a comfortable airflow is carried down to the floor level.

CRITERIA FOR CEILING HEIGHT AND NUMBER OF AIR DISCHARGE OUTLETS

		Number of air discharge outlets used							
		50-71				100-140			
Ceiling height	Standard	2.7 m	3.1 m	3.0 m	3.5 m	3.2 m	3.4 m	3.6 m	4.2 m
	High ceiling (1)	3.0 m	3.4 m	3.3 m	3.8 m	3.6 m	3.9 m	4.0 m	4.2 m
	High ceiling (2)	3.5 m	4.0 m	3.5 m	—	4.2 m	4.2 m	4.2 m	—

Note: Factory settings are for standard ceiling height and all-round flow. High ceiling settings (1) and (2) are set with the remote controller.

ADAPTS EASILY TO THE INSTALLATION SPACE

Because air flows out from corner outlets, comfort spreads more widely.

Typical flow patterns

There are a total of 23 flow patterns.

All-round flow



(E.g., installed in middle of ceiling)

3-way flow



(E.g., installed near a wall)

L-shaped 2-way flow



(E.g., installed in a corner)

Opposite 2-way flow



(E.g., installed in a long room)

4-way flow also possible.

Note: Whatever the discharge direction, the same type of panel is used. If installing for other than all-round flow, an air discharge outlet sealing member (option) must be used to close each unused outlet. Operation sound increases when using 2-way or 3-way flow.

TWO SELECTABLE TEMPERATURE-SENSORS

Both indoor unit and wired remote controller (option) contain temperature-sensors. Temperature sensing can be set at the unit or, to further improve comfort level, closer to the target area at the wired remote control. This feature requires initial setting by the installer. Temperature-sensor on indoor unit must be used when the air conditioner is controlled from another room. Wireless remote controller does not have a temperature-sensor.

HOT START (AFTER DEFROST)

Uncomfortable cold air draft is avoided when heating operation starts or when switching to heat after defrosting.

SWITCHABLE FAN SPEED: High/Low

High setting provides maximum reach while low setting minimises drafts.

TIMER SELECTOR

Operation starts when the preset time of the ON timer elapses and stops when the preset time of the OFF timer elapses.

COMPACT BODY AND QUIET OPERATION

Indoor unit	dB(A)	
	High	Low
50	35	28
60	35	28
71	35	28
100	43	32
125	44	34
140	44	36

Note: Anechoic chamber conversion value, measured according to JIS parameters and criteria. During operation these values are somewhat higher owing to ambient conditions.

3 CLEANLINESS

EXTERNAL PANELS ARE TREATED WITH A COATING THAT REPELS DIRT

- Grime prevention and bactericidal coating makes cleaning easier.

To prevent dirt sticking to the external panels, they have been coated with a surface treatment.

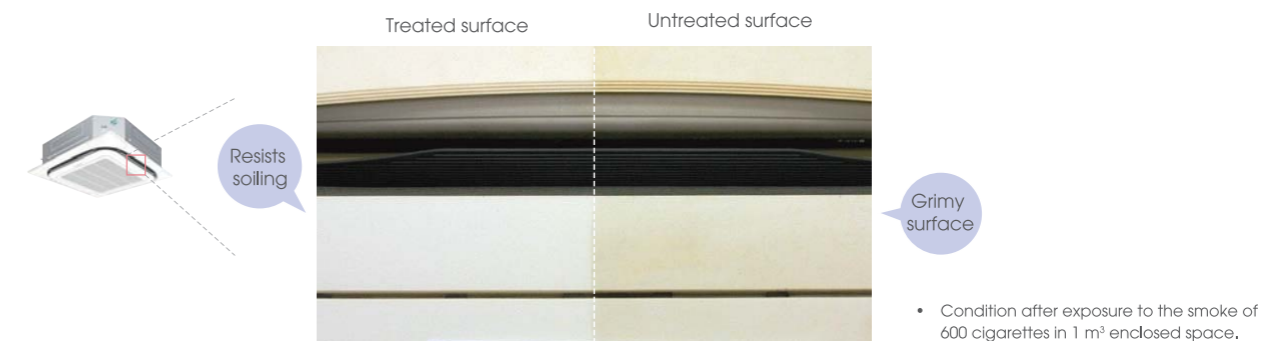

• Condition after exposure to the smoke of 600 cigarettes in 1 m³ enclosed space.

- Bactericidal treatment for drain pan

Anti-bacterial treatment, that includes silver ions is used which assists in preventing the growth of microorganisms that cause smell and clogging.

- Non-flocking horizontal louvres

Dew does not easily form and dirt does not cling to non-flocking louvres. It is easy to clean.

- Filter has anti-mould and bactericidal treatment

Prevents mould and microorganisms growing out of the dust and moisture that adheres to the filters.

PANEL SPACER

Use when only minimal space is available between drop ceilings and ceiling slabs.

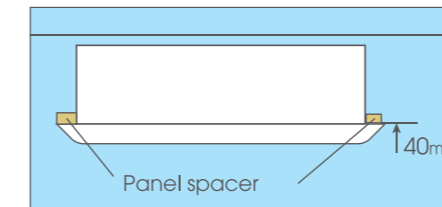

Note: Some ceiling constructions may hinder installation. Contact your Daikin Dealer before installing your unit.

UNIFIED SQUARE PANELS

Panels are the same size as the FCQ50-140. Maintains a neat appearance where multiple units are installed.

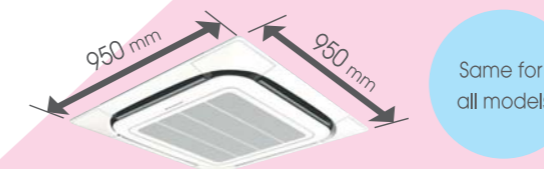

4 WORK & SERVICING

QUICK AND EASY TO INSTALL

Just 256 mm high. Can be installed in tight ceiling spaces (50-71).

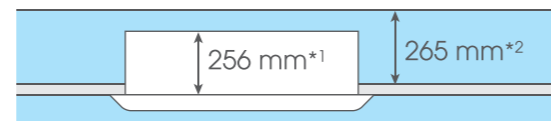

Note: *1 298 mm high with 100-140
*2 303 mm high with 100-140

EASY HEIGHT ADJUSTMENT

Each corner of the unit has an Adjuster Pocket that lets you easily adjust the unit's suspended height.

Note: If the wireless remote control option is installed, a light receptor unit is housed in one of the adjuster pockets.

EASIER TO MAINTAIN

The condition of the drain pan and drain water can be checked by removing the drain plug and intake grille.

Just open the intake grille!



Drain plug

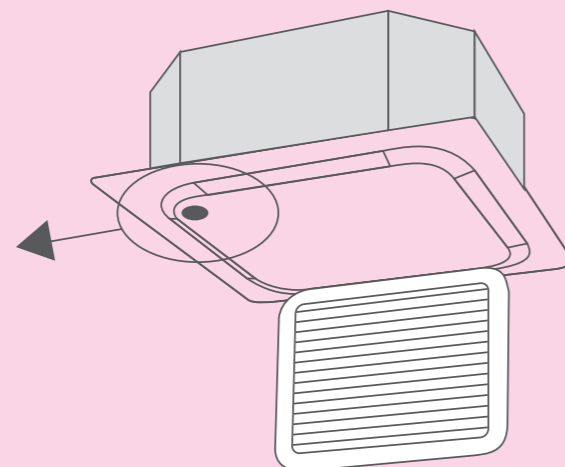

With ultra long-life filters (option), maintenance is not required in normal shops or offices for up to four years.

ROUND FLOW TYPE: LIST OF OPTIONAL PARTS REQUIRED TO ACHIEVE DIFFERENT FLOW PATTERNS

For each flow pattern – all round, 4-way, 3-way, 2-way, branch duct connection – the compatibility of each independently install option (shown in the column on the left) to accessory options (listed across the top of each table) is shown in the cells where the relevant row and column intersect. A circle (o) indicates compatibility, and a cross (x) indicates incompatibility. Any options not shown below are not suitable for independent or accessory installation.

All round flow 4-way flow

Optional accessory parts		Panel Spacer ¹	Wireless remote controller	Fresh air intake kit (Chamber type) ^{1,2}	Fresh air intake kit (direct mount)	High-humidity operation kit	High-efficiency filter ²	Ultra-long-life filter ²
Independently installable optional parts								
Panel/grille related	Panel spacer ¹		o	o	o	o	o	o
Operation control related	Wireless remote controller	o		o	o	o	o	o
	Fresh air intake kit (Chamber type) ^{1,2}	o	o		x	x	o	o
Auxiliary function related	Fresh air intake kit (direct mount)	o	o	x		o	o	o
	High-humidity operation kit	x	o	x	o		x	o
Filter related	High-efficiency filter ²	o	o	o	o	x		x
	Ultra-long-life filter ²	o	o	o	o	x	o	

3-way flow 2-way flow

Optional accessory parts		Panel Spacer ¹	Wireless remote controller	Fresh air intake kit (Chamber type) ^{1,2}	Fresh air intake kit (direct mount)	High-humidity operation kit	High-efficiency filter ²	Ultra-long-life filter ²
Independently installable optional parts								
Panel/grille related	Panel spacer ¹		o ³	o ³	o ³	x	x	o ³
Operation control related	Wireless remote controller	o ³		o	o	o	x	o
	Fresh air intake kit (Chamber type) ^{1,2}	o ³	o		x	x	x	o
Auxiliary function related	Fresh air intake kit (direct mount)	o ³	o	x		o	x	o
	High-humidity operation kit	x	o	x	o		x	o
Filter related	Ultra-long-life filter ²	o ³	o	o	o	x	x	x

Branch duct connection

Optional accessory parts		Panel Spacer ¹	Wireless remote controller	Fresh air intake kit (Chamber type) ^{1,2}	Fresh air intake kit (direct mount)	High-humidity operation kit	High-efficiency filter ²	Ultra-long-life filter ²
Independently installable optional parts								
Branch duct ¹ (Chamber type)	1-way branch / unit 3-way flow	o	o	o	o ⁴	x	x	o
	2-way branch / unit 2-way flow	x	o	o	o ⁴	x	x	o
(Round duct type)	1-way branch / unit 2-way flow	x	o	o	o ⁴	x	x	o

¹In some cases, depending on how the unit is embedded in the ceiling, use of branch ducts and fresh air intake kits may not be possible. Before starting installation work make sure to check whether or not joint installation is possible. In particular, ensure that the lower fixing position caused by the addition of panel spacers is acceptable.

²Use a chamber connection kit if two different types of optional chambers are used together. In this case, the fresh air intake kit must be installed in the upper position.

³It is not possible to use panel spacers in a 2-way flow installation.

⁴It is not possible to install a branch duct on the same side to which a fresh air intake kit (direct mount) is installed.

DRAIN PUMP IS EQUIPPED AS STANDARD ACCESSORY WITH 850 MM LIFT

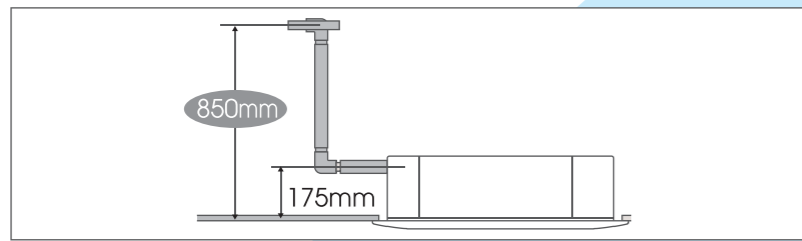

TRANSPARENT DRAIN SOCKET

Because the drain socket is transparent, after the drain piping has been installed, it is easy to check if the drain comes out through the socket.



EASIER CONNECTION WITH THE CENTRALISED CONTROL SYSTEM

ALL MODELS SUSPENDED WITHOUT LIFT INSTALLED IN ANY DIRECTION

Since the orientation of the intake grille can be adjusted after installing, the direction of the intake grille lines can be unified when multiple units are installed.

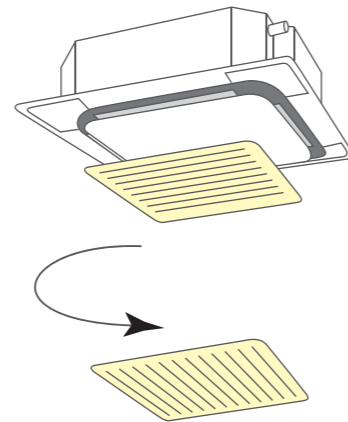

SEALING MEMBER OF AIR DISCHARGE OUTLET

Sealing members block air discharge openings not used in 2-way or 3-way blow.

BRANCH DUCT (DIRECT-CONNECTION ROUND DUCT)

A round duct can be attached without the need for a chamber.

A flanged port for direct connection of a round duct is provided. An existing branch duct chamber can also be fitted (square slit hole).

The units can be installed in the following different ways.

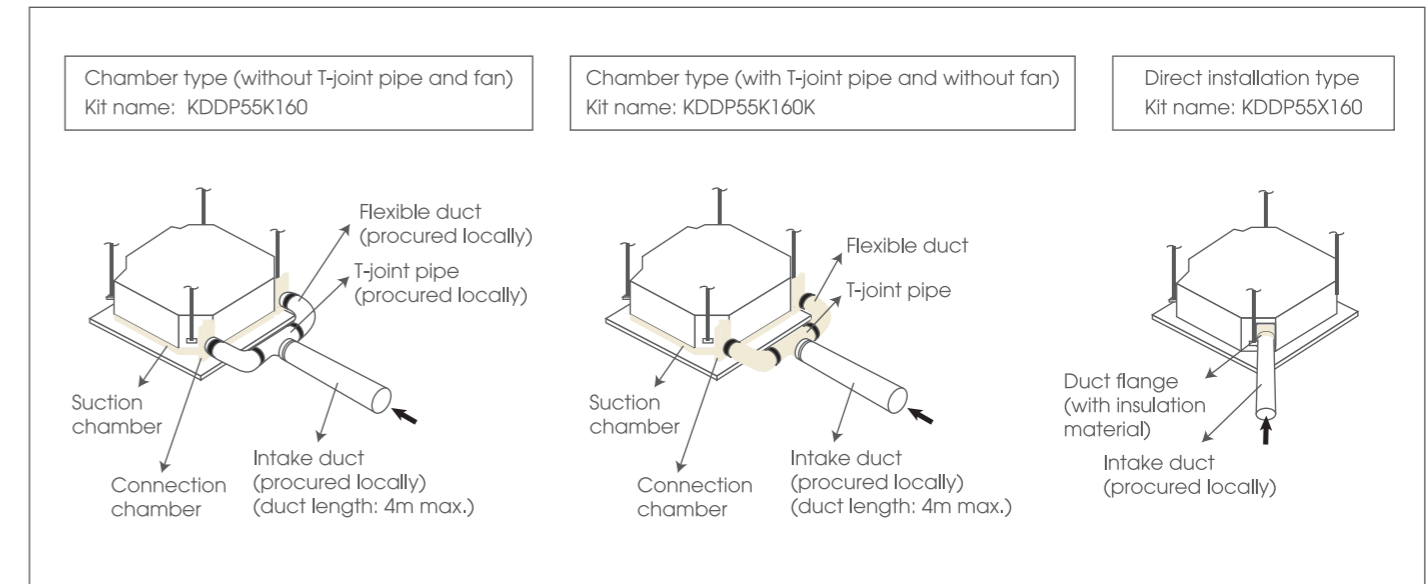

Note: Use of options will increase operating sound.

5 OPTIONS

OPTIONS REQUIRED FOR SPECIFIC INSTALLATION ENVIRONMENTS

ULTRA LONG-LIFE FILTER

Even in smoky environments where the air conditioner is on most of the time, the ultra long-life filter only has to be changed once a year.

Smoky atmosphere: annual filter change.
 *For dust concentration of 0.3mg/m³ (Requires separately sold Air Cleaner.) 1 year (Approx. 5,000 hr) = 15 hr/day x 28 day/month x 12 month/year.
 In ordinary stores and offices, filter change every 4 years.
 **For dust concentration of 0.15mg/m³ 4 years (Approx. 10,000 hr) = 8 hr/day x 25 day/month x 4 years.

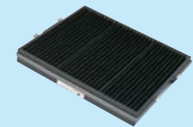

FRESH AIR INTAKE KIT

Using this kit, a duct can be fitted to increase the intake of outdoor air.

Note: *Connecting ducts, insect nets, fire dampers, air filters, and other parts should, as required, be procured locally.
 **Outside Air fan interlocked with airconditioning unit is necessary. Optional PCB (KRP1C63) is required for interlocking.
 ***It is recommended that the volume of outdoor air introduced through the kit is limited to 10% of the maximum airflow rate of the indoor unit. Introducing higher quantities will increase the operating noise and may also influence temperature setting.

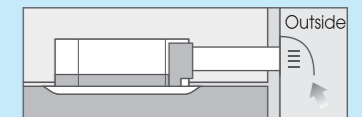

HIGH-EFFICIENCY FILTER

Available in two types: 65% and 90% colorimetry.



CEILING
SUSPENDED
TYPE

FHQ Series
Cooling Only & Heat Pump



Upgrade to a quiet and compact system.

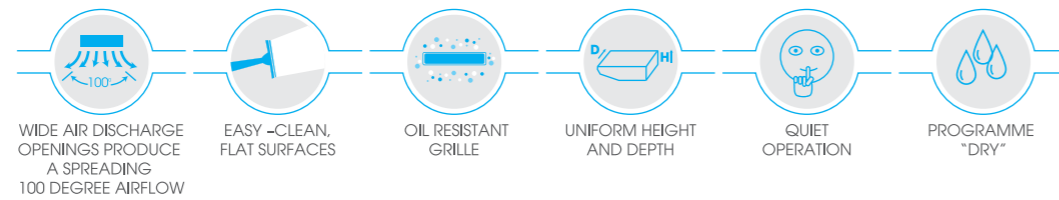

FHQ35BV~125BV (COOLING ONLY) FHQ35BV~125BV (HEAT PUMP) | 1 TR ~ 3.6 TR (COOLING ONLY) 1 TR ~ 3.6 TR (HEAT PUMP)

WIRED LCD REMOTE CONTROLLER WITH WEEKLY SCHEDULE TIMER

Standard

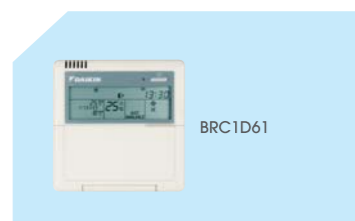

Note: Standard for both Cooling Only and Heat Pump models. Remote controller cable not included. Cables must be procured locally.

WIRED LCD REMOTE CONTROLLER

Option



Note: Remote controller cable not included. Cables must be procured locally.

WIRELESS LCD REMOTE CONTROLLER

Option

A signal receiver must be added to the indoor unit.



BRC7EA66 (Cooling Only)
BRC7EA63W (Heat Pump)



Signal receiver unit (Installed type)
Wireless remote controller and signal receiver unit are sold as a set.

NAVIGATION REMOTE CONTROLLER (H/P)

Option

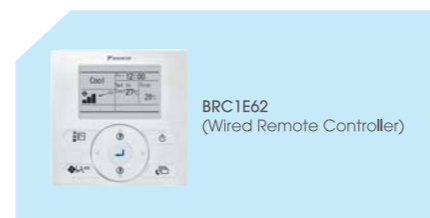

Note: Remote controller cable not included. Cables must be procured locally.

1 FEATURES

Feature	Comfort										Cleanliness	Work & Servicing					Control features				Others							
	Auto swing	Draft prevention function	Switchable fan speed (2 step)	Programme "Dry"	High ceiling application	Two selectable temperature-sensors	Hot start (after defrost)	Year-round cooling applicable	Night quiet operation	Timer selector		Weekly schedule timer	Anti-bacterial air filter	Drain pump mechanism	Pie charged for up to 30 m	Long-life filter	Filter sign	Low gas pressure detection	Emergency operation	Self-diagnosis function		Auto-restart	Auto-cooling/heating change-over	Control by 2 remote controllers	Group control by 1 remote controller	External command control	Central remote control	Interlock control
Cooling Only	•	—	•	•	*1	*2	—	—	*3	•	*4	•	*5	*3	•	•	*3	•	•	•	•	•	•	•	•	•	•	*3
Heat Pump	•	•	•	•	*1	*2	•	•	*3	•	*4	•	*5	*3	•	•	*3	•	•	•	•	•	•	•	•	•	•	*3

*1 Installable on max. 3.5 m high ceiling *2 Applicable when wired remote controller is used *3 For outdoor units *4 Applicable when BRC1D61 or BRC1E61 is used *5 Option

Sound Level
37/32 dB(A)
High Low
FHQ35BVV1B

2 COMFORT

AUTO-SWING (UP & DOWN) BRINGS COMFORT TO THE ROOM

DISTRIBUTES AIR EVENLY THROUGHOUT THE ROOM

WIDE AIR DISCHARGE OPENINGS PRODUCE A SPREADING 100° AIRFLOW.

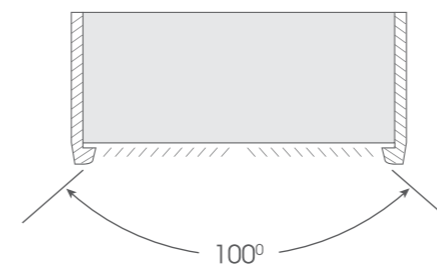

AIR IS BLOWN UP TO 50° IN THE DOWNWARD DIRECTION.

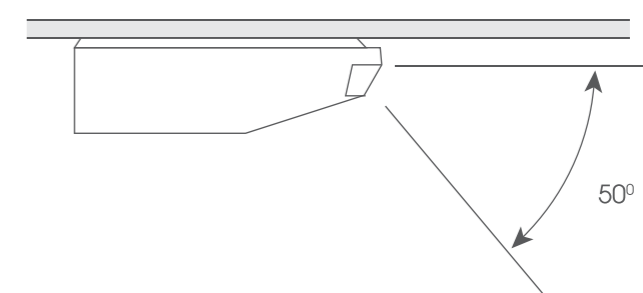

INSTALLABLE ON CEILINGS 3.5 M HIGH

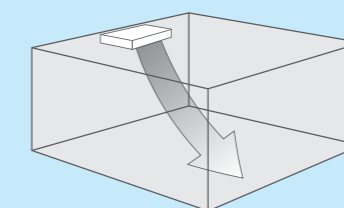

TWO SELECTABLE TEMPERATURE-SENSORS

Both indoor unit and wired remote controller (option (BRC1E61)) contain temperature-sensors. Temperature sensing can be set at the unit or, to further improve comfort level, closer to the target area at the wired remote control. This feature requires initial setting by the installer.

Temperature-sensor on indoor unit must be used when the air conditioner is controlled from another room. Wireless remote controller does not have a temperature-sensor.

SWITCHABLE FAN SPEED: High/Middle/Low

PROGRAMME "DRY"

Dehumidification is micro-processor controlled to prevent abrupt and uncomfortable changes in air temperature.

EASY-CLEAN, FLAT SURFACES

FOR ALL MAINTENANCE TASKS, ACCESS IS FROM BOTTOM SURFACE

OIL RESISTANT GRILLE

Oil-resistant plastic is used for the air discharge grille. This satisfies durability in restaurants and other similar environments.
 Note: Intended for use in salons, dining rooms, and ordinary sales floors, this specification is not suitable for kitchens or other harsh environments.

QUIET OPERATION

Sound operation has been reduced on the exposed ceiling suspended type unit.

Indoor unit	dB(A)	
	High	Low
35BV	37	32
50BV	38	33
60BV	39	33
71BV	39	35
100BV	42	37
125BV	44	39

Note: Anechoic chamber conversion value, measured according to JIS parameters and criteria. During operation these values are somewhat higher owing to ambient conditions.

Uses quiet stream fan and other quiet technologies.

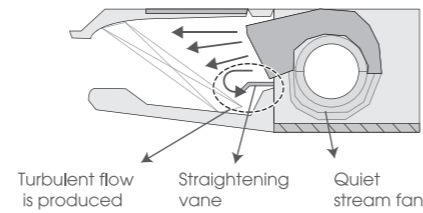

DRAIN PUMP KIT (OPTION) CAN BE EASILY INCORPORATED

Drain pipe connection can be done inside the unit. Refrigerant and drain pipe outlets are at the same opening.

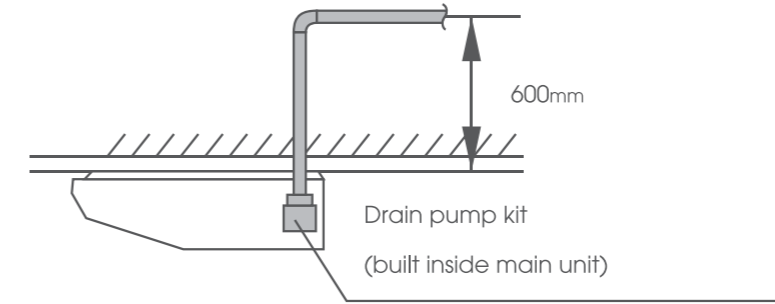

ALL WIRING AND INTERNAL SERVICING CAN BE DONE FROM UNDER THE UNIT

PIPES MORE EASILY RIGGED

LOW GAS PRESSURE DETECTION

(Applicable to RZQ71KBV4A, RZQ100/125KV4A, RZQ100/125HY4A outdoor units)

LONG-LIFE FILTER LASTS UP TO 6 MONTHS*

* For dust concentration of 0.15 mg/m³
 Two time settings (2500 hrs and 1250 hrs) are available to match the installation environment. Maintenance time warning is displayed on the remote controller (filter sign).

3 WORK & SERVICING

FLEXIBLE INSTALLATION FLEXIBILITY FOR FREEDOM OF DESIGN

UNIFORM HEIGHT AND DEPTH. COMPACT DESIGN FOR SMALL-CAPACITY MODELS TO MEET TIGHTER DIMENSIONAL SPACES

FLEXIBLE INSTALLATION

The unit fits more snugly into tight spaces.

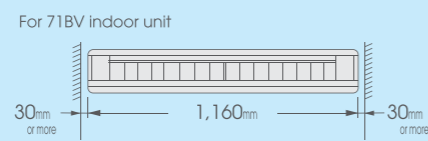

*Water used in the test-run can now be drained from the air discharge opening rather than from the side as was formerly the case.

NON-DEW FLAP BRISTLES MINIMISE CLINGING DIRT AND SIMPLIFY CLEANING

Absence of bristles minimises clinging dirt and simplifies cleaning.





FLOOR
STANDING
TYPE

FVQ Series
Cooling Only & Heat Pump



R-410A

Comfort through new airflow control.

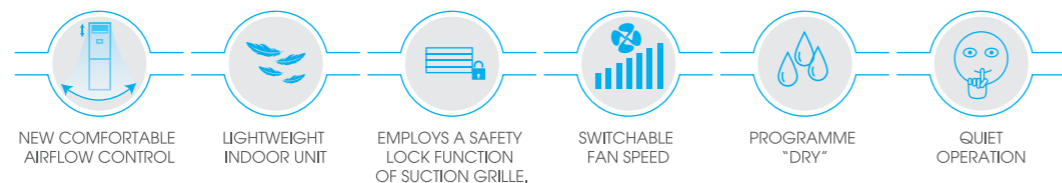

FVQ71~140
(COOLING ONLY/HEAT PUMP)

2.2 TR ~ 4 TR
(COOLING ONLY/HEAT PUMP)

ACCESSORY REQUIRED FOR INDOOR UNIT

NAVIGATION REMOTE CONTROLLER

Option



BRC1E62
(Wired Remote Controller)

Note: Remote controller cable not included. Cables must be procured locally.

1 FEATURES

Sound level
43/41/38dB(A)
High Medium Low
FVQ71CVEB

Feature	Comfort										Cleanliness	Work & Servicing				Control Features				Others						
	Auto swing	Independent up-and-down airflow	Switchable fan speed (3 step)	High fan speed mode	Programme 'Dry'	Two selectable temperature-sensors	Hot start (after defrost)	Year-round cooling applicable	Night quiet operation	Timer selector		Weekly schedule timer	Anti-bacterial air filter	Pie charged for up to 30 m	Long-life filter	Filter sign	Low gas pressure detection	Emergency operation	Self-diagnosis function		Auto-restart	Auto-cooling/heating change-over	Control by 2 remote controllers	Group control by 1 remote controller	External command control	Central remote control
Cooling Only	•	•	•	*1	•	*2	—	—	*3	•	*4	•	*3	•	•	*3	•	•	•	—	•	•	•	•	•	*3
Heat Pump	•	•	•	*1	•	*2	•	•	*3	•	*4	•	*3	•	•	*3	•	•	•	•	•	•	•	•	•	*3

*1Applicable for FVQ71/100 *2Applicable when wired remote controller is used *3For outdoor units *4Applicable when BRC1E61 is used

2 COMFORT

NEW COMFORTABLE AIRFLOW CONTROL

1. Left And Right Directions (By Remote Controller)

Auto swing direction is selectable from 3 patterns to suit the layout of the room.

Pattern 1 Wide swing toward the front

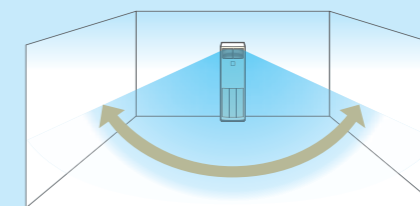

When installed in the center of a wall.

Pattern 2 Swing on the left side

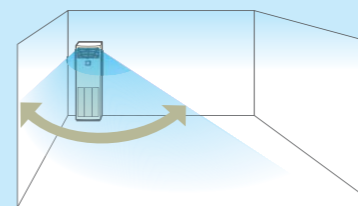

Pattern 3 Swing on the right side

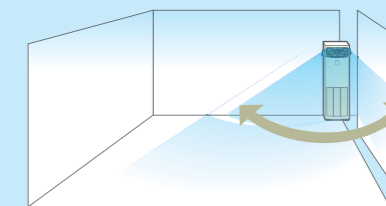

When installed in the corner of a room.

2. Up And Down Directions (By Hand)

Independent up and down airflow directions facilitate even room temperature and help save energy.

Freely select both up and down airflow direction with 8-louver (horizontal blade) operation.

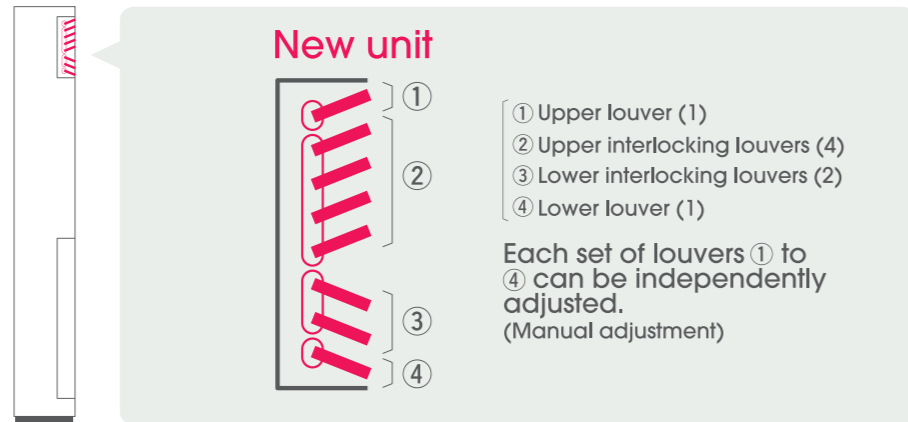

Example applications

When cooling

Turning louvers ① and ② upward and leaving ③ and ④ horizontal will reduce uneven room temperature.

When heating

Leaving louvers ① and ② horizontal and turning ③ and ④ downward will reduce uneven room temperature.

COMFORTABLE FAN SPEED CONTROL

HIGH FAN SPEED MODE (ONLY FVQ71/100)

To carry airflow to the far side of the room, airflow rate can be increased 5% or 10% depending on the installation condition or customer's request (Field setting by remote controller).

SWITCHABLE FAN SPEED: High/Middle/Low

PROGRAMME "DRY"

Dehumidification is micro-processor controlled to prevent abrupt and uncomfortable changes in air temperature.

ENERGY-SAVING

A DC FAN MOTOR IMPROVES EFFICIENCY

QUIET OPERATION

Indoor unit	dB(A)		
	High	Middle	Low
71 C	43	41	38
100 C	50	47	44
125 C	51	48	46
140 C	53	51	48

Note: Anechoic chamber conversion value, measured according to JIS parameters and criteria. During operation these values are somewhat higher owing to ambient conditions.

QUICK AND EASY INSTALLATION AND MAINTENANCE

3 WORK & SERVICING

LIGHTWEIGHT INDOOR UNIT

Enables smooth transport and installation of the indoor unit.

Indoor unit	(kg)			
	71 C	100 C	125 C	140 C
Weight	39		47	

LONG-LIFE FILTER LASTS ABOUT 1 YEAR*, MAINTENANCE NOT REQUIRED

* For dust concentration of 0.15 mg/ m

EMPLOYS A SAFETY LOCK FUNCTION OF SUCTION GRILLE

The grille will not open even upon impact.

EASIER CONNECTION WITH THE CENTRALISED CONTROL SYSTEM



CEILING
MOUNTED
SLIM DUCT TYPE

FDXS Series
Heat Pump



INVERTER

R-410A

Suitable for tight ceiling spaces

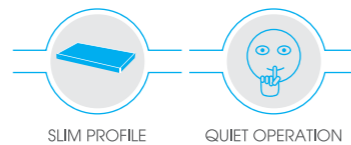

FDXS25~60C
(HEAT PUMP)

0.7 TR ~ 1.8 TR
(HEAT PUMP)

ACCESSORY REQUIRED FOR INDOOR UNIT

WIRED LCD REMOTE CONTROLLER

Standard



BRC944B2

Note: 3 m (BRCW901A03) or 8 m (BRCW901A08) length wired remote controller cord is necessary.

WIRELESS LCD REMOTE CONTROLLER

Option



ARC433B69



A signal receiver must be added to the indoor unit.

Signal receiver unit (Separate type)

Wireless remote controller and signal receiver unit are equipped as a set.

1 FEATURES

Sound level
35/31 dB(A)
High Low
FDXS25CVMA/FDXS35CVMA

Feature	Comfort		Work & Servicing		Control Features		Others
	Switchable fan speed	Programme "Dry"	Hot start	Pre-charged for up to 10m	Self-diagnosis function	Auto-restart	Automatic cool/heat change-over
Model							PE fin
Heat Pump	•	•	•	•	•	•	•

2 COMFORT

QUIET OPERATION

Indoor Unit Quiet Operation provides a low sound level of 29 dB(A) and Outdoor Unit Quiet Operation provides a low sound level of 44 dB(A) for FDXS25C.

SMOOTH FINISH

The only visible signs of these unobtrusive units are their discharge grilles. They fit completely inside the ceiling to maintain the original décor of a room. Each unit comes with its own wireless remote controller.

3 WORK & SERVICING

SLIM PROFILE

The new series adds a 2.5 kW model. All units share the same low height of just 200 mm. This means it is now possible to install a unit inside a shallow ceiling cavity with a height of just 240 mm.



DUCT CONNECTION
MIDDLE HIGH STATIC
PRESSURE TYPE

FBQ Series
Cooling Only & Heat Pump



R-410A

Flexible use of space is made possible using ducts to create a room filled with comfort.

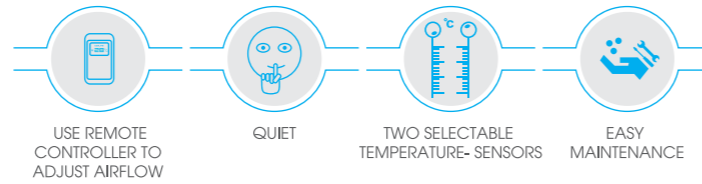

FBQ50~140D (COOLING ONLY)	1.5 TR ~ 4 TR (COOLING ONLY)
FBQ71~140D (HEAT PUMP)	2.2 TR ~ 4 TR (HEAT PUMP)

WIRED LCD REMOTE CONTROLLER
Standard



Note: Standard for both Cooling Only and Heat Pump models. Remote controller cable not included. Cables must be procured locally.

WIRED LCD REMOTE CONTROLLER WITH WEEKLY SCHEDULE TIMER
Option

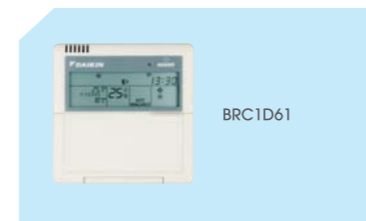

Remote controller cable not included. Cables must be procured locally.

WIRELESS LCD REMOTE CONTROLLER
Option

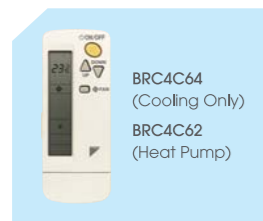

A signal receiver must be added to the indoor unit.



Wireless remote controller and signal receiver unit are sold as a set.

NAVIGATION REMOTE CONTROLLER
Option



Note: Remote controller cable not included. Cables must be procured locally.

1 FEATURES

Sound Level (Cooling Only) **37/32** dB(A)
High Low
FBQ50DV1

Sound Level (Heat Pump) **35/28** dB(A)
High Low
FBQ71DV1

Feature	Comfort				Cleanliness	Work & Servicing				Control Features				Options	Others												
	Switchable fan speed (2 step)	Programme "Dry"	Two selectable temperature-sensors	Hot start (after defrost) applicable	Year-round cooling	Night quiet operation	Timer selector	Weekly schedule timer	Anti-bacterial air filter	Silver ion anti-bacterial drain pan	Drain pump mechanism	Pre-charged for up to 30 m	Long-life filter	Filter sign	Low gas pressure detection	Emergency operation	Self-diagnosis function	Auto-restart	Auto-cooling/heating change-over	Control by 2 remote controllers	Group control by 1 remote controller	External command control	Central remote control	Interlock control	High-efficiency filter	Anti-corrosion treated heat exchangers	
Cooling Only	•	•	*1	—	—	*2	•	*3	*4	•	•	*2	*4	•	*2	•	•	•	—	•	•	•	•	•	•	•	*2
Heat Pump	•	•	*1	•	•	*2	•	*3	*4	•	•	*2	*4	•	*2	•	•	•	•	•	•	•	•	•	•	•	*2

*1 Applicable when wired remote controller is used *2 For outdoor units *3 Applicable when BRC1D61 or BRC1E61 is used *4 Option

2 COMFORT

QUIET OPERATION

Indoor unit	dB(A)	
	High	Low
50 D	37	32
60 D	37	32
71 D	37	32
100 D	38	33
125 D	40	36
140 D	40	36

TWO SELECTABLE TEMPERATURE-SENSORS

Both indoor unit and wired remote controller (option) contain temperature-sensors. Temperature sensing can be set at the unit or, to further improve comfort level, closer to the target area at the wired remote control. This feature must be set during commissioning by the technicians.

Temperature-sensor on indoor unit must be used when the air conditioner is controlled from another room. Wireless remote controller does not have a temperature-sensor.

INCREASED FREEDOM OF DESIGN, THANKS TO VARIABLE CONTROL OVER EXTERNAL STATIC PRESSURE

Comfort airflow achieved in accordance with conditions such as duct length. Using a DC fan motor, the external static pressure can be controlled within a range of 50 Pa to 200 Pa.

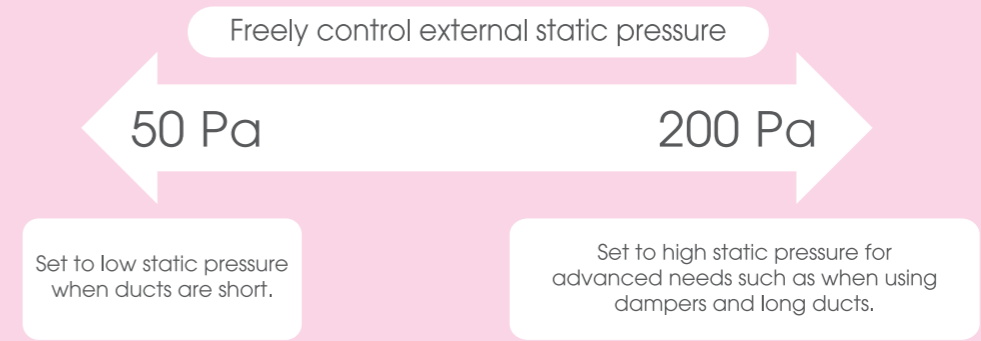

SIMULTANEOUS AIRCONDITIONING OF TWO ROOMS AND VENTILATION GRILLE (VENTILATION OPENING)

When airconditioning two rooms simultaneously, the air discharged into each room must be circulated back to the air conditioner. To achieve this, a ventilation duct should be installed for each room or one of the indicated ventilation grilles should be installed on the partitioning wall or under the door between the rooms.

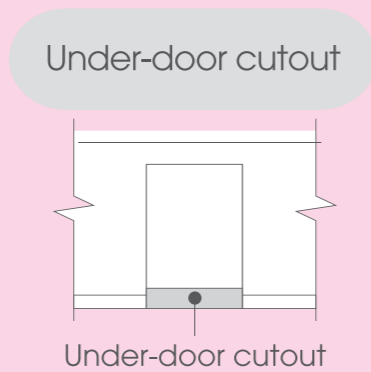
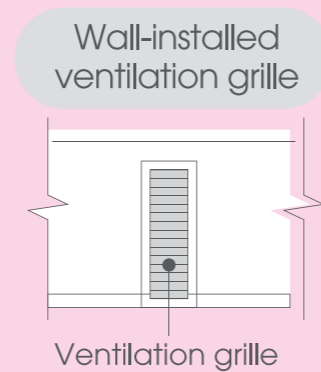
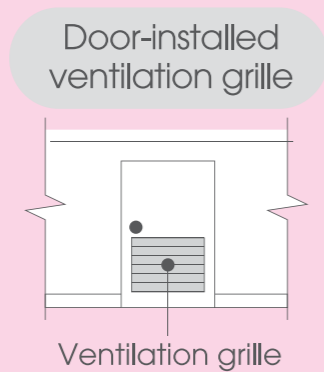
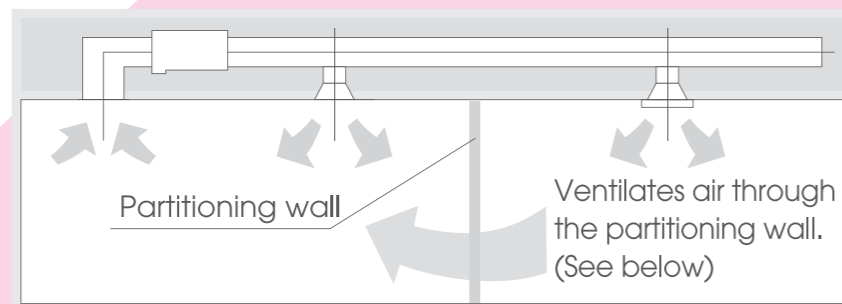

Note: The under-door cutout method should be used only when there is a small volume of airflow.

4 WORK & SERVICING

THIN, LIGHTWEIGHT INDOOR UNIT MAKES DELIVERY AND INSTALLATION EASY

With a height of only 300 mm, installation is possible even in buildings with narrow ceiling spaces.



Indoor unit	50 D	60 D	71 D	100 D	125 D	140 D
Height (mm)	300					
Width (mm)	1,000			1,400		
Depth (mm)	700					
Machine Weight (kg)	36			46		

Drain pump is equipped as standard accessory with 700 mm lift.

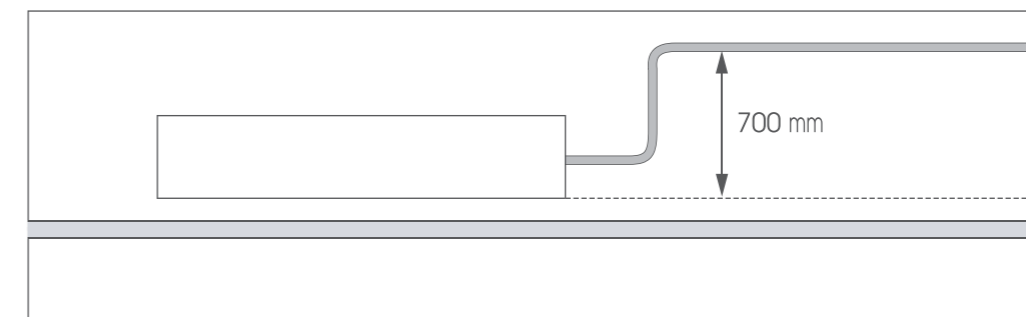

REDUCED INSTALLATION TIME

Use Remote Controller To Adjust Airflow

When testing standard integrated ceiling units that employ duct work, much time used to be required to adjust airflow to the right level. Thanks to the ability provided by Daikin to automatically perform this troublesome adjustment using a remote controller, this step is now quick and easy. (Adjust by H tap).

1. Adjust to approximately ±10% of the rated H tap airflow.
2. Once actual operation has begun, adjustment of the rated airflow is not possible.

EASY MAINTENANCE

Maintenance is easy because the drain pan can be removed.

3 CLEANLINESS

BACTERICIDAL TREATMENT FOR DRAIN PAN

Anti bacterial treatment, that includes silver ions, is used which assists in preventing the growth of microorganisms that cause smells and clogging.



OUTDOOR
UNITS



OUTDOOR UNITS - NON INVERTER



1 COMPACT & QUIET

EQUIPPED WITH SCROLL COMPRESSOR FOR QUIETER OPERATION

Smooth running, minimal vibration, low operating noise.

(Applicable for R36-56NU); (RY71-140LU); (R71-125LU); (R71FU) & (R(Y)35-50DG)



C Series		dB(A)	
Cooling only & Heat pump Outdoor unit	Sound Level		
R(Y)10CGXV16	46		
R(Y)15CGXV16	49		
R(Y)20CGXV16	51		

KA Series		dB(A)	
Cooling only Outdoor unit	Sound Level (cool/heating)		
RY35FV	47/48		
RV50GA	49/51		
RY60GA	54/54		
RY71LU	48/49		

K Series		dB(A)	
Cooling only Outdoor unit	Sound Level		
R25GV	45		
R35GA	48		
R50GA	49		
R60GV	54		
R71FU	52		

LU Series		dB(A)	
Heat pump Outdoor unit	Sound Level (cool/heating)		
RY50GA	49/51		
RY60GA	54/54		
RY71LU	48/49		
RY100LU	49/52		
RY125LU	49/52		
RY140LU	54/56		

E Series		dB(A)	
Cooling only & Heat pump Outdoor unit	Sound Level		
R(Y)20CGXV16	51		
R(Y)25CGXV16	52		
R(Y)28CGXV16	58		
R(Y)35DGXV16	58		
R(Y)40DGXY16	58		
R(Y)50DGXY16	58		

LU Series		dB(A)	
Cooling only Outdoor unit	Sound Level		
R71LU	48		
R100LU	49		
R125LU	49		
R140LU	54		

NU Series		dB(A)	
Cooling only Outdoor unit	Sound Level		
R18NUV1	49		
R21NUV1	54		
R26NUV1	57		
R30NUV1	57		
R36NUV1	55		
R42NUV1	57		
R48NUV1	59		
R51NUV1	59		
R56NUV1	56		

2 POWERFUL

(High-reliability new refrigerant circuit)

Uses "Receiver" to enhance refrigerant control

(Applicable for R71-140)

Unlike the system whereby excess refrigerant is absorbed by an accumulator, a "Receiver" is provided in the liquid piping away from the compressor to collect excess refrigerant.

This prevents return of liquid to the compressor and enhances reliability.

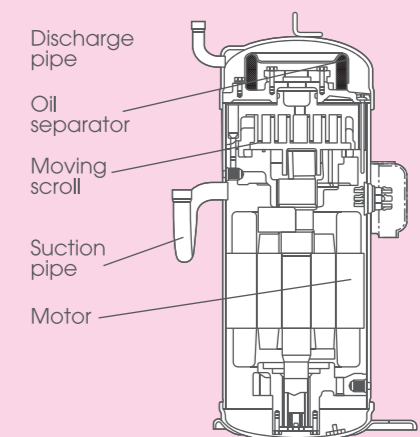

SLIM-DESIGN AND LOW-PROFILE COMPACT OUTDOOR UNITS

Compactly designed outdoor unit with interior layout optimised for the smooth flow of air.

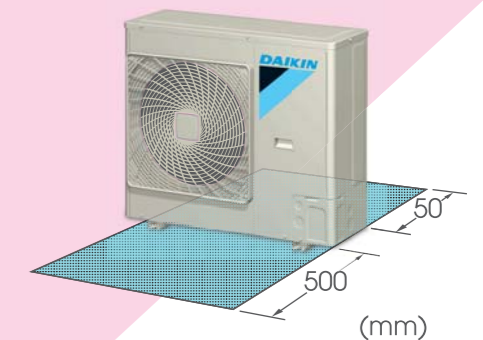

WEIGHT REDUCED

(Applicable for R71-140)

Delivery and installation are easier.

Curved Super Aero Grille restricts the spread of exhaust gas and fits in the same space as previous outdoor units.

ENERGY-EFFICIENT, COMFORTABLE OPERATION BY FUZZY CONTROL

Fuzzy control precisely controls actuation of electronic expansion valve according to variation in operating conditions.

WIDE OPERATION RANGE

(Applicable for R71-140) (Optional available)

Cooling operation is possible when outdoor temperature is from -15°C to 46°C.

4-DIRECTION PIPING AFFORDS MORE FREEDOM OF LAYOUT

(Applicable for R71-140) & (R26-R51)

Piping can be run from the front, bottom, right or rear surface according to how the unit is installed.

LOW GAS LEVEL DETECTION FUNCTION

(Applicable for R71-140)

Effective gas monitoring reduces the labour required for operation, maintenance and repairs.

3 DURABILITY

(Takes installation environment into consideration)

HEAT EXCHANGE FINS PROVIDED WITH ANTI-CORROSION TREATMENT

To achieve increased durability and improved resistance to salt corrosion and atmospheric pollution, coated PE fins (with special acryl pretreatment) are used for the heat exchanger of the outdoor unit.

Greater corrosion resistance

Corrosion resistance grade	Against salt corrosion		Against acid corrosion	
	Non-treated fin	PE fin	Non-treated fin	PE fin
	1	5-6	1	5-6

INSTALLATION AND MAINTENANCE

(Smoother and easier)

PRE-CHARGED FOR UP TO 30 METRES (LU)

(Applicable for R/RV71-140) (R-Cooling only, RV-Heat Pump)

If refrigerant piping length does not exceed 30 m, there is no need for on-site gas charging.

Allowed refrigerant pipe length and height difference

	Pre-charged *1	Max. length	Max. height difference
R25	10 m	25 m	15 m
R35/RV35	10 m	25 m	15 m
R50/RV50	10 m	30 m	15 m
R60/RV60	5 m	30 m	15 m
R71/RV71	30 m	50 m (Equivalent length 70m)	30 m
R100/RV100	30 m	50 m (Equivalent length 70m)	30 m
R125/RV125	30 m	50 m (Equivalent length 70m)	30 m
R140/RV140	30 m	50 m (Equivalent length 70m)	30 m

Note: *1 Additional refrigerant charging is required if the refrigerant pipe is longer than the indicated length. For more information, see the engineering data.

PRE-CHARGED FOR UP TO 15 METRES

(R-Cooling only)

If refrigerant piping length does not exceed 5m (R36, R42, R48, R51, R56) *Outdoor used with FDMG

10m (R18, R21, R26, R30, RNQ18-26), 15m (R36, R42, R48, RNQ30-48), there is no need for on-site gas charging.

Allowed refrigerant pipe length and level difference

	Pre-charged *1	Max. length	Max. level difference
R26	10 m	30 m (Equivalent length 50 m)	20 m
R30	10 m	30 m (Equivalent length 50 m)	20 m
R36/R36*2	15m/5 m	30 m (Equivalent length 50 m)	20 m
R42/R42*2	15m/5 m	30 m (Equivalent length 50 m)	20 m
R48/R48*2	15m/5 m	30 m (Equivalent length 50 m)	20 m
R51*2	5 m	30 m (Equivalent length 70 m)	20 m
R56*2	5 m	50 m (Equivalent length 70 m)	30 m

Note: *1 Additional refrigerant charging is required if the refrigerant pipe is longer than the length. *2 Outdoor used with FDMG. For more information, see the engineering data.

FITTED WITH WIDE INLET FAN

(Applicable for R71-140) & (R26NU-51NU)

Fully shaped aerodynamic propellers are designed to push air with a large wing surface.

This provides both high blow volume and quiet operation with minimal turbulence.

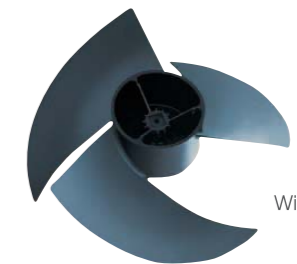

Wide inlet fan

FITTED WITH SUPER AERO GRILLE

(Applicable for R71-140) & (R26NU-51NU)

To suppress turbulence and achieve quiet operation, the curved ribs of the grille are optimised to meet the outflow of air.





RZR50LUV1
RZR60LUV1
RZR71LUV1



RZR100LUV1



RZR100LUV1
RZR125LUV1/Y1
RZR140LUV1/Y1

INVERTER R-410A

NEW COMPACT OUTDOOR UNIT - INVERTER

1 EASY INSTALLATION AND MAINTENANCE

Pre charged for up to 30 metres.

If refrigerant piping length does not exceed 30 m, there is no need for on-site gas charging.

LONG PIPING LENGTH

■ Allowed refrigerant piping length and level difference		
	RZR50-140LU RZQ71KC	RZQ100-140KC RZQ100-140HA
Pre charged ¹	30 m	
Max. length	50 m (Equivalent length 70m)	75 m (Equivalent length 90m)
Max. level difference	30 m	

Note: ¹Additional refrigerant charging is required if the refrigerant pipe is longer than the length.

COMPACT AND LIGHTWEIGHT

Reduced installation work thanks to light, compact outdoor unit.

■ Comparison of outdoor units	
Conventional (RZR100KU)	NEW (RZR100LU)
Height 1,170 mm	990 mm
Weight 92 kg	78 kg

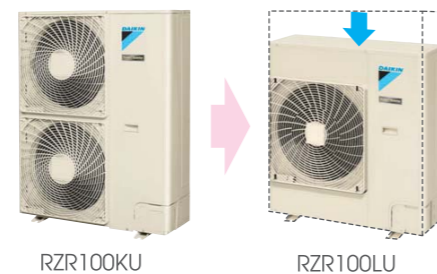

Reduced by 180 mm

Reduced by 14 kg



RZQ71KCV4A



RZQ100KCV4A
RZQ125KCV4A
RZQ140KCV4A



RZQ100HAY4A
RZQ125HAY4A
RZQ140HAY4A

4-DIRECTION PIPING OFFERS GREATER LAYOUT FREEDOM

(not applicable for RZR50-71)

The outer panel for the piping connection part of the front, right side and backside can be removed and is easier for post-installation piping work.

FACILITATES PUMP-DOWN

(Refrigerant recovery function)

A pump-down switch is provided to make it easier to collect refrigerant if the unit is to be moved or layout modified.

Pump-down function is available for pre-charged refrigerant amount.

LOW GAS PRESSURE DETECTION FUNCTION

Effective gas monitoring reduces the labor required for operation, maintenance, and repairs.

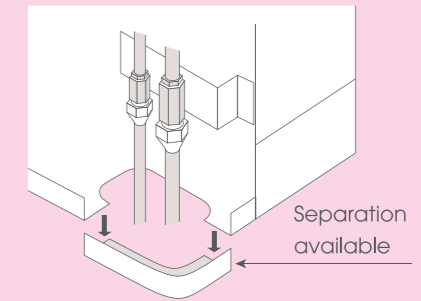

Separation available

2 ENERGY SAVING

(RZR50-71 only)

Through use of a V-cut propeller fan that imitates the efficiency of the swan, a migratory bird, airflow becomes smooth and loss is reduced.



Ø550 V-cut propeller fan

Imitating the performance of the swan

3 DURABILITY

As the bottom frame is subjected to corrosion, corrosion-proof galvarium steel plate is adopted to enhance the durability. Heat exchange fins provided with anti-corrosion treatment.



4 DEMAND CONTROL FUNCTION

The maximum capacity is maintained within a set level of power consumption, which makes it possible to keep comfort and effective demand control.

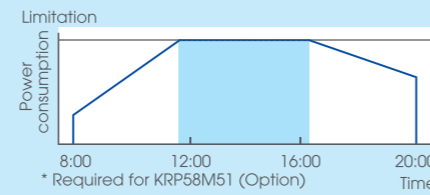

5 NIGHT TIME QUIET OPERATION FUNCTION

The Automatic Night Quiet Mode will initiate 8 hours after the peak temperature is reached in the daytime, and normal operation will resume 10 hours after that.
(By remote controller at site)

★ Reducing noise will reduce capacity slightly.

Cooling only	Heat pump	Sound level ¹ (dB(A))	
		Rated ²	Night Quiet Mode
RZR50/60LU	—	48	44
RZR71LU	RZQ71KC	48	44
RZR100LU	RZQ100KC/100HA	49	45
RZR125LU	RZQ125KC/125HA	50	45
RZR140LU	RZQ140KC/140HA	50	46

Note: ¹ Anechoic chamber conversion value, measured according to JIS parameters and criteria. During operation these values are somewhat higher owing to ambient conditions. ² Value when cooling. Value will differ when heating.

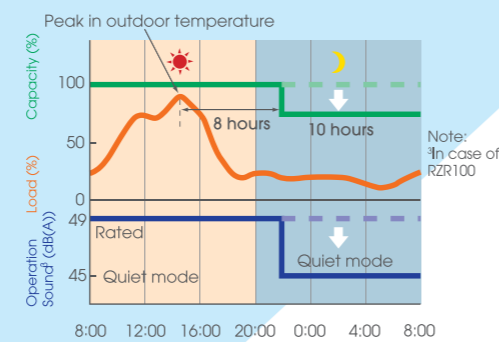

6 TECHNOLOGY FOR ENERGY EFFICIENCY

The High Efficiency Compressor to achieve a high COP.

1 Compressor equipped with Reluctance DC motor

Daikin DC Inverter models are equipped with the Reluctance DC motor for compressor. The Reluctance DC motor uses 2 different types of torque, neodymium magnet¹ and reluctance torque². This motor can save energy because it generates more power with a smaller electric power than an AC or conventional DC motor.

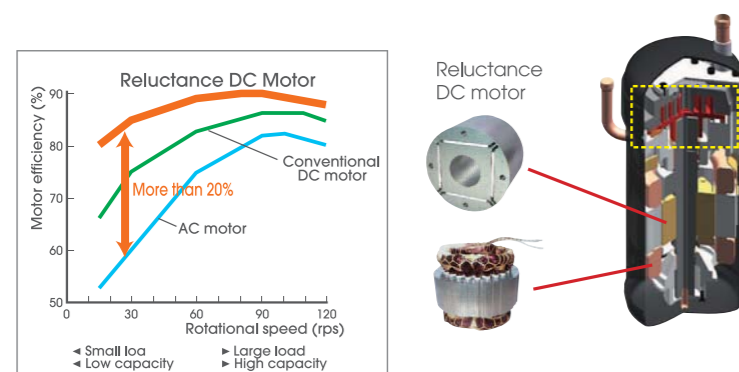

Note: Data are based on studies conducted under controlled conditions at a Daikin Laboratory.
¹. A neodymium magnet is approximately 10 times stronger than a standard ferrite magnet.
². The torque created by the change in power between the iron and magnet parts.

>> Smooth sine wave DC inverter

Use of an optimised sine wave smoothes motor rotation, further improving operating efficiency.



RZR50/60/71/100LUV1
RZQ50/60KB, RZQ71KC

>> Swing compressor
Energy savings are realised, eliminating the friction and the leakage of refrigerant gas.

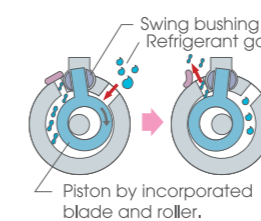

RZR125/140LUV1, RZR100/125/140LUV1
RZQ100/125/140KC, RZQ100/125/140HA

>> The structural scroll
Sucked gas is compressed in the scrolling part before the heated motor, so that the machine compresses the non-expanded gas, resulting in high efficiency compression.

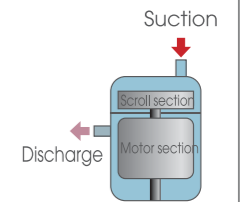

2 Smooth Air Inlet Bell Mouth and Aero Spiral Fan

(not applicable for RZR50-71)

These two features work to reduce noise. Guides are added to the bell mouth intake to reduce turbulence in the airflow generated by fan suction. The Aero Spiral Fan features fan blades with the bent blade edges, further reducing turbulence.

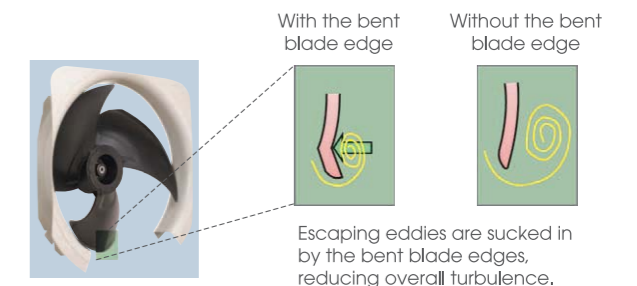

3 DC Fan Motor

Efficiency improved in all areas compared to conventional AC motors, especially at low speeds.

DC fan motor structure

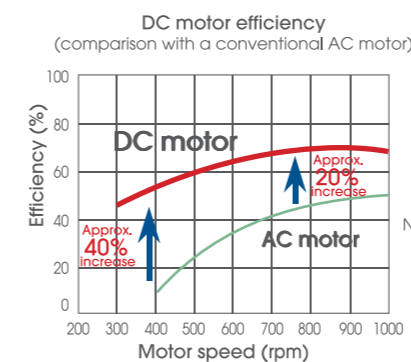

Note: Data are based on studies conducted under controlled conditions at a Daikin laboratory.

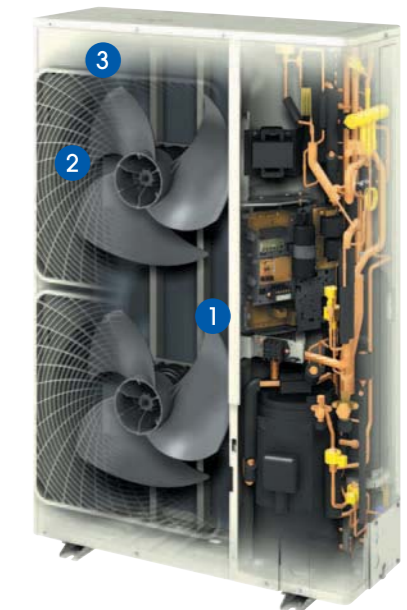

4 Super Aero Grille

Refined ventilation mechanism enables further reduction in required fan power.

COMFORTABLE

ENHANCED COMFORT WITH INVERTER

Inverter performs variable control of frequency, which determines air conditioner's power performance. At startup, full power is used to achieve the set temperature quickly. Then, the capacity is adjusted according to the outdoor temperature changes and subtle indoor load changes to achieve fine capacity control resulting in a more stable room temperature. Non-inverter type air conditioners must be switched on and off repeatedly, causing large fluctuations of the room temperature.

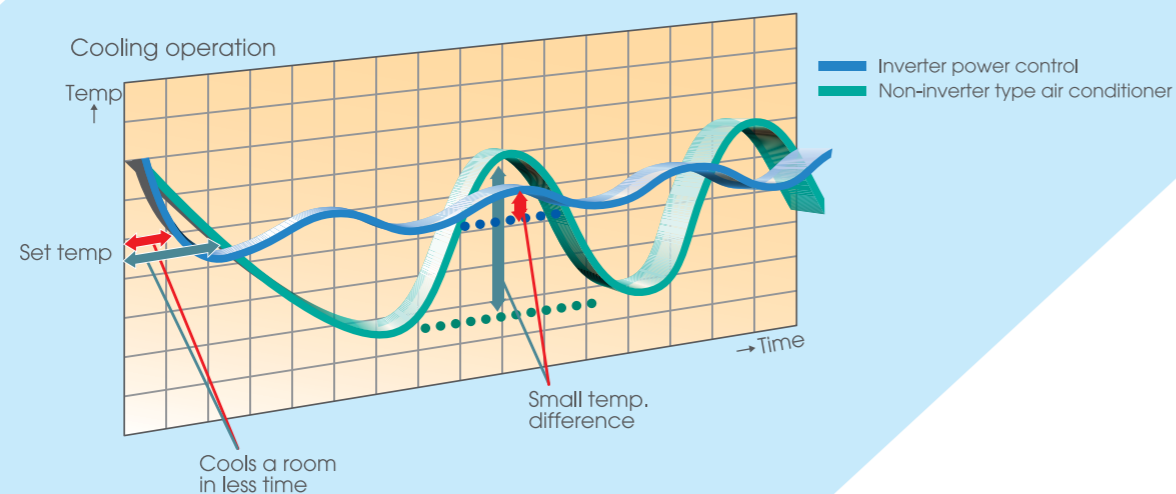

ENERGY SAVING

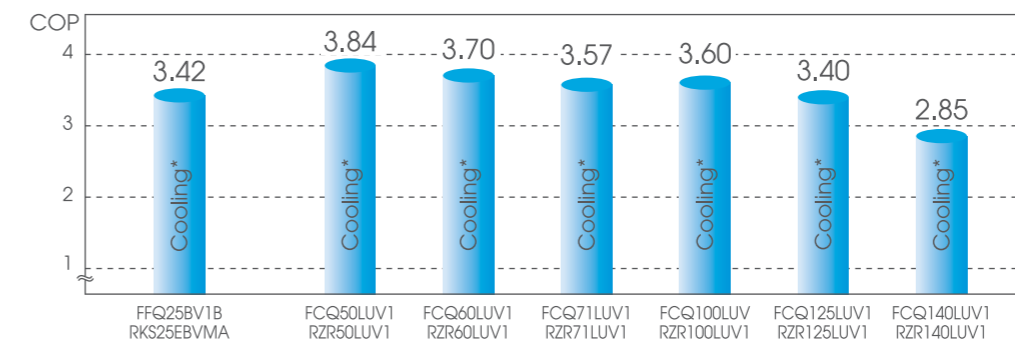

Note: *Rated cooling capacities are based on the following conditions: Indoor temp., 27°CDB, 19.0°CWB; outdoor temp., 35°CDB, 24.0°CWB. Equiv. refrigeration piping, 7.5 m (horizontal).

What is COP (Coefficient of Performance)

COP is equal to capacity (kW) divided by power consumption (kW), and the larger the COP value, the higher the energy efficiency, enabling cooling and heating with less electricity and increasing the energy saving performance.



RZR100LUV1



Soft starter is unnecessary, making electrical installation work much simpler.

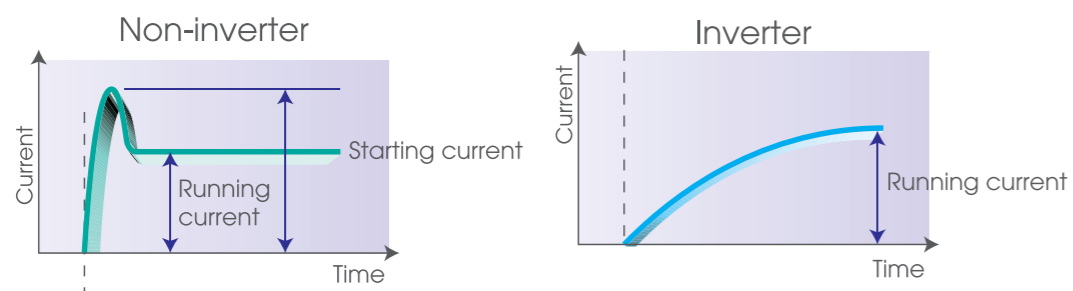

At startup, inverter raises frequency smoothly, eliminating the starting current spike.

	Sound level ¹ (dB(A))	
	Rated ²	Night Quiet Mode
RZR50/60LUV1	48	44
RZR71LUV1	48	44
RZR100LUV1/Y1	49	45
RZR125LUV1/Y1	50	45
RZR140LUV1/Y1	50	46

Note: ¹Anechoic chamber conversion value, measured according to JIS parameters and criteria. During operation these values are somewhat higher owing to ambient conditions. ²Value when cooling. Value will differ when heating.

NECESSARY OPTIONAL ACCESSORY

CONTROLLERS

Easy-to-read LCD remote controller allows various system control configurations and can control multiple indoor units.
(Remote controller options are shown on the page introducing each indoor unit model).

1 NAVIGATION REMOTE CONTROLLER (Wired Remote Controller BRC1E62)



CLEAR DISPLAY, SIMPLE OPERATION, "NAVIGATION REMOTE CONTROLLER"

This simple, modern designed remote controller with fresh white colour matches your interior design. Operation is much easier and smoother. Just follow the indications on the navigation remote controller.

AUTO OPERATION MODE

2 Set points

Display set temperatures at both cooling and heating operations.

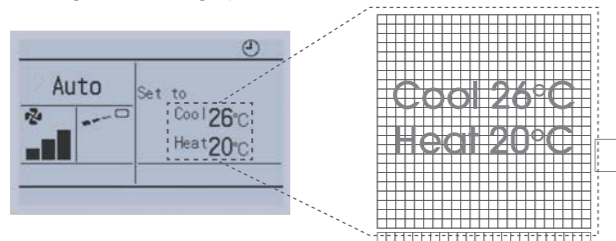

Backlight display

Equipped backlight helps operating in dark rooms.



Weekly schedule timer

The schedule timer for each day of the week can be set up easily (3 patterns).

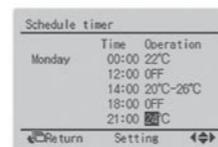

SIMPLE OPERATION

Large buttons and arrow keys



Large buttons and arrows keys for easy operation. Basic settings such as fan speed and temperature can be intuitively operated. For other settings just select the function from the menu list.

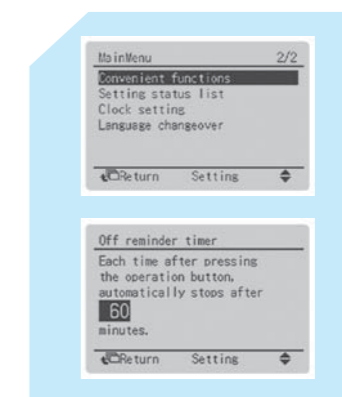

Guide on display
The display gives an explanation of each setting for easy operation.

OTHER FEATURES

Multilingual display

Display is available in 11 languages (English, German, French, Spanish, Italian, Portuguese, Greek, Dutch, Russian, Turkish and Polish).



2 WIRED LCD REMOTE CONTROLLER

Easier to read because LCD screen is larger.

- For easier operation, louvre switches, which are frequently used, have been made larger.
- Oil-resistant plastic casing increases durability.
- Only 17mm thick. Can be installed either recessed or exposed.



2A WIRED LCD REMOTE CONTROLLER WITH WEEKLY SCHEDULE TIMER

Remote control is equipped with weekly timer function.

- 24-hour clock function.
- Programming function for each day of week.
- Scheduling possible of start/stop and temperature limit (5 settings/day).



NON INVERTER

	WIRED REMOTE CONTROLLER	C/O	H/P
1	Round Flow Ceiling Mounted Cassette Type (FCNQ)	BRC1C61 (Standard)	—
2	Ceiling Mounted 2x2 Cassette Type (FF/FFC C-Series)	BRC51A62	BRC51A61
3	Ceiling Mounted 3x3 Cassette Type (FHC/FFYC E-Series)	BRC51A62	BRC51A61
4	Ceiling Mounted Cassette Type (FHC/FHYC)	BRC1C61 (Standard)	BRC1C61 (Standard)
5	Ceiling Suspended Cassette Type (FUY)	BRC1C61 (Standard)	—
6	Wall Mounted Type (FAY)	BRC1C61 (Standard)	—
7	Ceiling Suspended Type (FH/FHY)	BRC1NU61 (Standard)	BRC1C61 (Standard)
8	Floor Standing Type (FVY)	BRC1C61	—
9	Duct Connection Low Static Pressure Type (FDB/FDYB)	KRC47-2A (Standard) KRC47-4A KRC47-1A	BRC1C61 (Standard)
10	Duct Connection Middle Static Pressure Type (FDMG/FDYM)	KRC47-2A KRC47-4A KRC47-1A (Standard)	BRC1C61 (Standard)

INVERTER

	WIRED REMOTE CONTROLLER	C/O	H/P
1	Compact Multi Flow Ceiling Mounted Cassette type (FFQ)	BRC1C61 BRC1D61 (Standard) BRC1E62	BRC1C61 BRC1D61 (Standard) BRC1E62
2	Round Flow Ceiling Mounted Cassette Type (FCQ)	BRC1C61 (Standard) BRC1D61 BRC1E62	BRC1C61 BRC1D61 (Standard) BRC1E62
3	Ceiling Suspended Type (FHQ)	BRC1C61 BRC1D61 (Standard) BRC1E62	BRC1C61 BRC1D61 (Standard) BRC1E62
4	Floor Standing Type (FVQ)	BRC1E62	BRC1E62
5	Ceiling Mounted Slim Duct Type (FDXS)	—	BRC944B2 (Standard)
6	Duct Connection Middle High Static Pressure Type (FBQ)	BRC1C61 (Standard) BRC1D61 BRC1E62	BRC1C61 (Standard) BRC1D61 BRC1E62

WIRED REMOTE CONTROLLER HAS BUILT-IN THERMO-SENSOR

(Applicable For BRC1C61)

Enables temperature detection closer to target area for improved comfort. (When using remote control from another room, thermo-sensor in indoor unit's air inlet must be selected.)

Note: The indoor unit's thermo-sensor is specified at the time of shipment. Thermo sensing with the wired remote controller is not available with the ceiling mounted cassette corner, ceiling-mounted built-in, and duct connection type.

FACILITATES MAINTENANCE AND REPAIR

(Applicable For BRC1C61)

- All initial settings can be set from the remote controller. After interior construction is complete, ceiling mounted units can be remotely set without having to use stepladder access for manual setting.
Setting contents: High ceiling use, air direction, filter type, address for centralised control (group control address is set automatically).
- Remote controller is equipped with model name and failure display functions. This facilitates service in the unlikely event of a malfunction.

NON-POLAR, DOUBLE-CORE CONNECTION SPECIFICATIONS SIMPLIFY WIRING

(Applicable For BRC1C61)

Non-polar, double-core remote controller wire prevents wiring mistakes. Signal receiver unit (or decoration panel) of wireless type is also easy to connect.

SKYAIR SHARES COMMON CONTROL WITH HEAT RECLAIM VENTILATOR AND THE OTHER DAIKIN AIRCONDITIONING UNITS, THUS SIMPLIFYING INTERLOCKING OPERATIONS

(Applicable For BRC1C61)

- Easily adaptable to large-scale, high-function, centralised remote control systems.
Installing and connecting control wiring between SkyAir and other Daikin airconditioning equipment is easy.
- Optional adaptor for external commands or remote control of external equipment has been standardised to one type.

3 WIRELESS LCD REMOTE CONTROLLER

Signal receiver mounted type

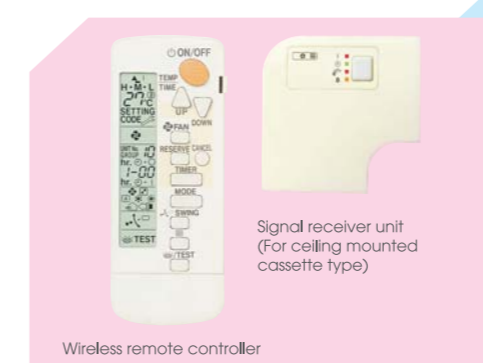

- The wireless remote controller is supplied in a set with a signal receiver.
- Shape of signal receiver unit differs according to the indoor unit.

Note: The signal receiver unit shown in the photograph is for mounting inside the decoration panel of the ceiling mounted cassette type.

NON INVERTER

	WIRELESS REMOTE CONTROLLER	C/O	H/P
1	Round Flow Ceiling Mounted Cassette Type (FCNQ)	BRC7F633F	—
2	Ceiling Mounted 2x2 Cassette Type (FF/FFY C-Series)	BRC52A62 (Standard)	BRC52A61 (Standard)
3	Ceiling Mounted 3x3 Cassette Type (FHC/FFYC E-Series)	BRC52A62 (Standard)	BRC52A61 (Standard)
4	Ceiling Mounted Cassette Type (FHC/FHYC)	BRC7C613W	BRC7C612W
5	Ceiling Suspended Cassette Type (FUY)	BRC7C529W	—
6	Wall Mounted Type (FAY)	BRC7E619 (FAY71) BRC7C611W (FAY100)	—
7	Ceiling Suspended Type (FH/FHY)	BRCNU66	BRC7E63W
8	Duct Connection Low Static Pressure Type (FDB/FDYB)	—	BRC4C62
9	Duct Connection Middle Static Pressure Type (FDMG/FDYM)	—	BRC4C62

INVERTER

	WIRELESS REMOTE CONTROLLER	C/O	H/P
1	Compact Multi Flow Ceiling Mounted Cassette type (FFQ)	BRC7E531W	BRC7E530W
2	Round Flow Ceiling Mounted Cassette Type (FCQ)	BRC7F633F	BRC7F632F
3	Ceiling Suspended Type (FHQ)	BRC7EA66	BRC7EA63W
4	Ceiling Mounted Slim Duct Type (FDXS)	—	ARC432B69
5	Duct Connection Middle High Static Pressure Type (FBQ)	BRC4C64	BRC4C62

LCD PANEL SHOWS OPERATING STATUS IN LETTERS, NUMBERS AND MOTION

(Applicable for BRC1C61)

Air flow / Swing display	Displays auto-swing operating status and setting position of air discharge angle (Not available for ceiling mounted built-in type and duct connection type).
Preset temperature / Operation mode display	Displays preset room temperature and operating status (fan, dry, cool).
Programming time display	Operation start and stop time can be set for individual timers up to 72 hours. The liquid crystal display also shows when it is time to clean the filter, when changeover is under centralised control, and ventilation/cleaning.
Self-diagnosis function	Monitors operating status within the system covering 40 items, and displays a message to indicate as soon as a malfunction occurs.

SIMPLE SYSTEM PROVIDES A DIVERSE ASSORTMENT OF CONTROL MODES.

(Applicable For BRC-type Controller)

	Control pattern	Wired remote controller	Wireless remote controller
Control by 1 remote controller	(Basic system)	 • Non-polar, double-core, (max. wiring length 500 m)	 • Signal receiver unit installed on indoor unit.
Control by 2 remote controllers	For control from 2 locations such as in room and control room, exits, etc.	 • Connects 2 wired remote controllers.	 • Control by 1 wireless remote controller and 1 wired remote controller. (See note 1) • Signal receiver unit installed on indoor unit.
Group control	For simultaneous control of up to 16 indoor units.	 • Automatic address setting function.	 • Automatic address setting function. • Signal receiver unit installed on 1 indoor unit.
Control by external command	Operation and surveillance is carried out using the contact signal from the operation control box in the building surveillance (security) room.	 • Optional wiring adaptor for electrical appendices is necessary.	 • Optional wiring adaptor for electrical appendices is necessary.
Central remote control	Centralised control of up to 64 indoor units from remote location up to 1 kilometer away.	 • Optional SkyAir series interface adaptor required. ¹⁾	 • Optional SkyAir series interface adaptor required. ¹⁾
Interlock control with Heat Reclaim Ventilator	Link by remote controller group control.	 • Can be operated simultaneously or independently by remote controller. (set by ventilation mode).	 • Can be operated simultaneously by remote controller. (set by ventilation mode)
	Zone link control by centralised control.	 • Heat Reclaim Ventilator for indoor units within a zone are operated by interlocking. Can also be operated independently by remote controller. • Optional interface adaptor for SkyAir series is necessary. ¹⁾	 • Heat Reclaim Ventilator for indoor units within a zone are operated by interlocking. • Optional interface adaptor for SkyAir series is necessary. ¹⁾

Note: When a wireless remote controller is used, remote control by two remote controllers is not possible. ¹⁾DIII-net adaptor function is standard equipment for the FAY71L.

Set back time clock
BRC15A61 (Option)



When connected to a BRC-type wired remote controller, the user can apply two sets of ON—OFF times at increments of up to 30 minutes per day. For each ON—OFF setting a temperature setting is also possible.

EASILY ADAPTABLE TO LARGE-SCALE, HIGH-FUNCTION, CENTRALISED REMOTE CONTROL SYSTEM

Central remote controller
DCS302B61 (Option)



Centralised control, with setting as simple as it is with a standard remote controller, of up to 64 groups (1,024 indoor units) is possible.

Interface adaptor for SkyAir series
DTA102A52 (Option)

Unified on/off controller
DCS301B61 (Option)



Centralised control of on/off by group or all at once for up to 256 indoor units.

Enables centralised control via connection to a high-speed, DIII-NET communication system, adopted for the Daikin VRV system. Necessary for interface adaptor for SkyAir series with the central remote control units shown at above.

Schedule timer
DST301B61 (Option)



Unified control of weekly schedule for up to 1,024 indoor units. Schedule timer sets on/off time in 1 minute units to be executed twice a day for a week at a time.

Central control adaptor kit²⁾
DTA107A55 (Option) (for FD series)

²⁾The central control adaptor kit for FDB series can be made to order.

Intelligent Control
DCS601C51 (Option)



With its high functionality, the full colour "all-in-one" graphic controller facilitates management of Sky Air System in a variety of ways.

Note: DIII-net adaptor function is standard equipment for the FAY71.

FUNCTION LINE UP

ABUNDANCE OF FUNCTIONS THAT PROVIDE COMFORTABLE AIRCONDITIONING IN STORES AND OFFICES.

1 COMFORT

AUTO SWING

Delivers comfortable airconditioning to all areas, near or far from the air conditioner.

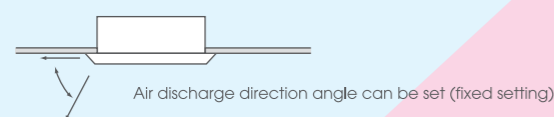

SWING PATTERN SELECTION (Draft prevention, standard, ceiling soiling prevention)

You can freely set 3 air flow positions by remote controller.

- Applicable for ceiling mounted cassette type and ceiling mounted cassette corner type.

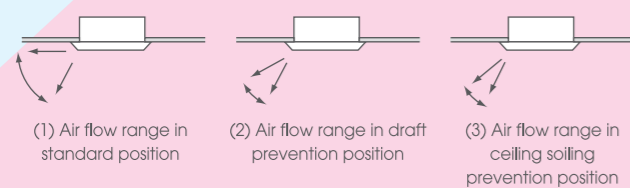

DRAFT PREVENTION FUNCTION (Heating)

To prevent cold air drafts, it automatically adjusts air flow to horizontal vector when heating initially starts or when the thermostat turns off.

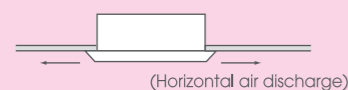

SWITCHABLE FAN SPEED

High setting provides maximum reach while low setting minimises drafts.

PROGRAMME "DRY"

Dehumidification is computer controlled to prevent abrupt and uncomfortable changes in air temperature. Useful for reducing discomforting humidity without uncomfortable cooling of the room.

HIGH FAN SPEED MODE

You can increase fan speed approximately 10% higher than the "high" setting.

- Applicable for wall mounted type.

MOULD-RESISTANT TREATMENT FOR FILTER

Sanitary filter has mould-resistant treatment.

HIGH-CEILING APPLICATION

Delivers airconditioning comfort all the way down to the floor in airconditioning zones with high ceilings.

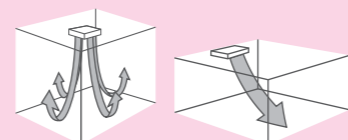

Note: When units are installed on high ceilings, depending on the model, various restrictions concerning maximum height, air discharge direction, and choice of options may apply.

TWO SELECTABLE THERMO-SENSORS

Thermo-sensors are included in the indoor unit and optional wired remote controller. Temperature detection closer to target area is possible to further increase the comfort level.

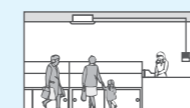

- Use the thermo-sensor in the indoor unit when controlling airconditioning from another room.
Note: Wireless remote controllers have no thermo-sensor.

HOT START (AFTER DEFROST)

Uncomfortable cold air draft is not discharged when heating operation starts or when switching to heat after defrosting.

YEAR-ROUND COOLING APPLICABLE

Efficient cooling even in winter when indoor temperatures are higher than those outside, such as in underground public spaces or office with many computers.

- Heat Pump/R71-140LU: possible up to -5°C
- Cooling Only/R71-140LU: possible up to -15°C
(An option is required.)

TIMER SELECTOR

Operation starts when the preset time of the ON timer elapses and stops when the preset time of the OFF timer elapses.

MILDEW PREVENTION

MILDEW-PROOFING DRAIN PAN

Mildew proofing maintains hygiene by preventing growth in highly humid conditions.

OTHERS

TWIN / TRIPLE / DOUBLE TWIN MULTI OPERATION

Simultaneously operates 2-4 indoor units with a single outdoor unit.

PE FIN

To achieve increased durability by improved resistance to salt corrosion and atmospheric pollution, coated PE fins (with special acryl pre-treatment) are used for the heat exchanger of the outdoor unit.

2 WORK & SERVICING

DRAIN WATER LIFT-UP MECHANISM

Steeper gradient ensures more efficient wastewater drainage. High-lift is especially useful for long lengths of drain piping.

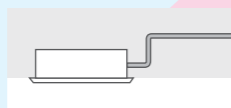

LONG-LIFE FILTER

Maintenance is not required for one year (two years when a ceiling mounted cassette type is used).

CEILING SOILING PREVENTION FUNCTION

Daikin's innovative air discharge mechanism keeps air flow away from the ceiling. Ceiling cleaning is less frequently required.

PRE-CHARGED FOR UP TO 15 METERS & 30 METERS FOR NU & LUV SERIES

If refrigerant piping length does not exceed 30 m, there is no need for on-site gas charging.

3 CONTROL FEATURES

AUTO-RESTART

If there is a power outage while the equipment is operating, operations will restart in the same mode as before the power cut when electricity is restored.

AUTO COOL/HEAT CHANGE-OVER (Heat Pump only)

Detects difference in preset temperature and actual room temperature and automatically switches to cooling or heating accordingly.

CONTROL BY 2 REMOTE CONTROLLERS

Using 2 remote controllers you can operate the equipment locally or from a remote location.

Note: When a wireless remote controller is used, remote control by two remote controllers is not possible.

INTERLOCK CONTROL

Enables interlocking control with external equipment such as Heat Reclaim Ventilator.

4 OPTIONS

HIGH-EFFICIENCY FILTER UNIT

Two types are available: 65% and 90% colorimetry. Superior filtering ratio easily meets building maintenance laws.

ULTRA LONG-LIFE FILTER

Requires no maintenance for about 4 years* (10,000 h) in stores and offices.

*For dust concentration of 0.15mg/m³

LOW GAS PRESSURE DETECTION

Insufficient gas charging is normally hard to detect. During post-installation trials and regular inspection procedures, the refrigerant level is monitored by computer to ensure proper gas pressure. Reliability is assured and maintenance and inspection can be carried out more quickly.

EMERGENCY OPERATION

If there is a malfunction elsewhere in the system, the fan or compressor can still be operated.

SELF DIAGNOSIS FUNCTION

The operating parameters of indoor and outdoor units, and sensor data at critical locations throughout the system are constantly monitored using a microcomputer. To facilitate quick response in the event of a malfunction, a message appears on the LCD of the remote controller and an LED on the unit illuminates.

FILTER SIGN

The filter sign warns you when it is time to clean the filter. *When using a wired remote controller the sign is displayed in the LCD. When using a wireless remote controller the filter sign lamp illuminates on the signal receiver unit.

CONTROL BY 1 REMOTE CONTROLLER

You can turn up to 16 indoor units on/off with a single remote controller. (When using connected indoor units, the settings must all be the same and on/off will be simultaneous.)

EXTERNAL COMMAND CONTROL

Operation and surveillance is carried out using the contact signal from the operation control box in the building surveillance (security) room.

CENTRAL REMOTE CONTROL

Optional central remote controller enables centralised control of up to 1024 indoor units (64 groups) from up to 1 kilometer away.

FRESH-AIR INTAKE KIT

You can provide airconditioning with fresh air from outside. Convenient for places where a ventilation fan cannot be installed.

SPECIFICATIONS

ROUND FLOW CEILING MOUNTED CASSETTE TYPE (Cooling Only)

R-410A

Model Name	Indoor unit		18		21		26		30		36		42		48				
	Outdoor unit		FCNQ18MVI RNQ18MVI	FCNQ21MVI RNQ21MVI	FCNQ26MVI RNQ26MVI	FCNQ30MVI RNQ30MVI	FCNQ36MVI RNQ36MVI	FCNQ42MVI RNQ42MVI	FCNQ48MVI RNQ48MVI	1 Phase, 220-240 V, 50 Hz									
Power supply			1 Phase, 220-240 V, 50 Hz																
Cooling capacity (Rated)	Btu/h		18000	21000	26000	30000	36000	42000	48000	3 Phase, 380-415 V, 50 Hz									
Power consumption	Cooling		1.89	2.21	2.53	2.73	3.31	4.15	5.04										
Indoor unit	Colour		Fresh White																
	Airflow rate (H/L)		m ³ /min	13/10	21/13.5	32/20		33/22.5											
	Sound level (H/L)		cfm	459/353	741/477	1130/706		1165/794											
	Dimensions (HxWxD)		dB(A)	31/28	35/28	43/32		44/34											
	Machine weight		mm	256x840x840		298x840x840		24											
	Certified operation range		kg	19.5	21	5.5		24											
	Colour		°CWB	14 to 28 Ivory white															
Outdoor unit	Compressor		Hermetically sealed rotary type																
	Type		Hermetically sealed scroll type																
	Motor output		kW	1.4	1.8	2.2	2.2	2.7	3.75	4.5									
	Refrigerant charge (R-410A)		kg	1.4 (Charged for 10 m)	1.5 (Charged for 10 m)	2.0 (Charged for 10 m)	1.9 (Charged for 15 m)	3.2 (Charged for 15 m)	2.7 (Charged for 15 m)	3.2 (Charged for 15 m)									
	Sound level		dB(A)	595x845x300		735x825x300		990x940x320		1,345x900x320									
	Dimensions (HxWxD)		mm	40	49	56	77	103	107	111									
	Machine weight		kg	19.4 to 46		21 to 46		21 to 46											
Piping connections	Liquid (Flare)		mm		Ø6.4		Ø9.5												
	Gas (Flare)		mm		Ø12.7		Ø15.9												
	Drain		mm		Ø18.0 (Hole)		Ø26.0 (Hole)												
	Max. interunit piping length		m	30		30 (Equivalent length 50)		50 (Equivalent length 70)											
Max. installation level difference		m	15		20		30												

Notes: ¹ Nominal cooling capacities are based on the following conditions: Return air temp., 27°CDB, 19.0°CWB; Outdoor temp., 35°CDB Equiv.ref.piping: 7.5m (Horizontal)
² Anechoic chamber conversion value, measured under JIS conditions. During actual operation, these values are normally somewhat higher as a result of ambient conditions.
 Capacities are net, including a deduction for cooling (an addition for heating) for indoor fan motor heat.
 In case of drain piping for outdoor unit, drain piping kit (option) is needed.
 RNQ26/30/36 is also available in 3-phase

SPECIFICATIONS

CEILING MOUNTED C-SERIES 2 x 2 CASSETTE TYPE (Heat Pump)

R-22

Model Name	Indoor unit		10		15		20		
	Outdoor unit		FF10CXV16 RY10CGXV16	FF15CXV16 RY15CGXV16	FF20CXV16 RY20CGXV16				
Power Supply			1 Phase, 220-240 V, 50 Hz						
Cooling Capacity	Btu/h		9500	12500	19000				
	kW		2.78	3.66	5.57				
Heating Capacity	Btu/h		9500	12500	19500				
	kW		2.78	3.66	5.72				
Power Consumption	Cooling		0.92	1.21	1.83				
	Heating		0.82	1.06	1.78				
Indoor Unit	Colour		White						
	Air Flow (H/M/L)		cfm	410/360/330		450/410/340			
	Sound Level (H/M/L)		dB(A)	41/38/35	41/38/34	44/41/37			
	Dimensions (HxWxD)		mm	250x570x570		45x640x640			
	Machine weight		kg	22	23				
	Certified operation range		°CWB	14 to 23					
	°CDB		15 to 27						
Outdoor Unit	Colour		Light Grey						
	Compressor		Rotary						
	Type		Rotary						
	Motor Output (kW)		Cooling	0.81	1.07	1.69			
	Heating		0.71	0.92	1.64				
	Refrigerant charge (R-22)		kg	0.63 (Charged for 7.6m)	0.93 (Charged for 7.6 m)	1.35 (Charged for 7.6 m)			
	Sound Level		dB(A)	46	49	51			
Dimensions (HxWxD)		mm	540x700x250		651x855x328				
Machine weight		kg	30		47				
Certified operation range		Cooling	19 to 46						
Heating		-9 to 18							
Piping Connections	Liquid (Flare)		mm						
	Gas (Flare)		mm		6.35		15.88		
Max. interunit piping length		m	12		15				
Max. installation level difference		m	5		8				
Heat insulation		Both Liquid and gas piping							

Note: Rated cooling capacities are based on the following conditions: Indoor temp., 27°CDB, 19°CWB; outdoor temp. 35°CDB.
 Rated heating capacities are based on the following conditions: Indoor temp., 20°CDB; outdoor temp., 7°CDB, 6°CWB.
 All unit are being tested and comply to ISO 5151 (Non-ducted unit)

CEILING MOUNTED C-SERIES 2 x 2 CASSETTE TYPE (Cooling Only)

R-22

Model Name	Indoor unit		10		15		20		
	Outdoor unit		FF10CXV16 R10CGXV16	FF15CXV16 R15CGXV16	FF20CXV16 R20CGXV16				
Power Supply			1 Phase, 220-240 V, 50 Hz						
Cooling Capacity	Btu/h		9500	12500	19000				
	kW		2.78	3.66	5.57				
Power Consumption	Cooling		0.92	1.21	1.83				
	Heating								
Indoor Unit	Colour		White						
	Air Flow (H/M/L/SL)		cfm	410/360/330		450/410/340			
	Sound Level (H/M/L)		dB(A)	41/38/35	41/38/34	44/41/37			
	Dimensions (HxWxD)		mm	250x570x570		45x640x640			
	Machine weight		kg	22	23				
	Certified operation range		°CWB	14 to 23					
	Light Grey		Light Grey						
Outdoor Unit	Compressor		Rotary						
	Type		Rotary						
	Motor Output		kW	0.81	1.07	1.69			
	Refrigerant charge (R-22)		kg	0.63 (Charged for 7.6m)	0.75 (Charged for 7.6 m)	1.35 (Charged for 7.6 m)			
	Sound Level		dB(A)	46	49	51			
	Dimensions (HxWxD)		mm	540x700x250		651x855x328			
	Machine weight		kg	28		47			
Certified operation range		°CDB	19 to 46						
Piping Connections	Liquid (Flare)		mm						
	Gas (Flare)		mm		6.35		15.88		
Max. interunit piping length		m	12		15				
Max. installation level difference		m	5		8				
Heat insulation		Both Liquid and gas piping							

Note: Rated cooling capacities are based on the following conditions: Indoor temp., 27°CDB, 19°CWB; outdoor temp. 35°CDB.
 All unit are being tested and comply to ISO 5151 (Non-ducted unit)

CEILING MOUNTED E-SERIES 3 x 3 CASSETTE TYPE (Cooling Only)

R-22

Model Name	Indoor unit		20		25		28		35		40		50		
	Outdoor unit		FHC20EXV16 R20CGXV16	FHC25EXV16 R25CGXV16	FHC28EXV16 R28CGXV16	FHC35EXV16 R35DGXV16	FHC40EXV16 R40DGXV16	FHC50EXV16 R50DGXV16	1 Phase, 220-240 V, 50Hz						
Power Supply			1 Phase, 220-240 V, 50Hz										3 Phase, 380-415 V, 50Hz		
Cooling Capacity	Btu/h		19500	25000	27000	35000	39500	49500							
	kW		5.72	7.33	7.91	10.26	11.60	14.50							
Power Consumption	Cooling		1.96	2.54	2.72	3.01	3.66	4.60							
	Heating														
Indoor Unit	Colour		White												
	Air Flow (H/M/L/SL)		cfm	600/530/430/400	680/600/530/430	860/725/620/530	1030/860/740/620	1200/1030/930/780							
	Sound Level (H/M/L/SL)		dB(A)	34/32/30/28	37/34/33/32	42/38/35/33	47/44/40/36	49/45/43/39							
	Dimensions (HxWxD)		mm	265x820x820		75x990x990		300x820x820							
	Machine weight		kg	26	28	31	39	41							
	Certified operation range		°CWB	14 to 23											
	Light Grey		Light Grey												
Outdoor Unit	Compressor		Rotary												
	Type		Rotary												
	Motor Output		kW	1.79	2.32	2.45	2.58	3.22	4.12						
	Refrigerant charge (R-22)		kg	1.35 (Charged for 7.6 m)	1.50 (Charged for 7.6 m)	1.75 (Charged for 7.6 m)	2.0 (Charged for 7.6 m)	2.48 (Charged for 7.6 m)	2.45 (Charged for 7.6 m)						
	Sound Level		dB(A)	51	52	58									
	Dimensions (HxWxD)		mm	651x855x328	753x855x328		852x1030x400								
	Machine weight		kg	47	57		95	100	105						
Certified operation range		°CDB	19 to 46												
Piping Connections	Liquid (Flare)		mm						6.35		9.52				
	Gas (Flare)		mm		15.88		19.05		25						
Max. interunit piping length		m	15		45		25								
Max. installation level difference		m	8		25		25								
Heat insulation		Both Liquid and gas piping													

Note: Rated cooling capacities are based on the following conditions: Indoor temp., 27°CDB, 19°CWB; outdoor temp. 35°CDB.
 All unit are being tested and comply to ISO 5151 (Non-ducted unit)

SPECIFICATIONS

CEILING CASSETTE E SERIES, 3 x 3 CASSETTE TYPE (Heat Pump)



Model Name	Indoor unit		20		25		28		35		40		50	
	Outdoor unit		FHYC20EXV16	FHYC25EXV16	FHYC28EXV16	FHYC35EXV16	FHYC40EXV16	FHYC50EXV16	FHYC20EXV16		FHYC25EXV16		FHYC28EXV16	
Power supply			1 Phase, 220-240 V, 50Hz				3 Phase, 380-415 V, 50Hz							
Cooling Capacity	Btu/h		19500	25000	27000	35000	42000	48000						
	kW		5.7	7.3	7.9	10.3	11.6	14.1						
Heating Capacity	Btu/h		19500	25000	28000	35000	42000	50000						
	kW		5.7	7.3	8.2	10.3	12.3	14.7						
Power Consumption	Cooling	kW	1.96	2.54	2.72	3.01	3.50	4.81						
	Heating	kW	1.69	2.31	2.35	2.75	3.19	4.21						
Indoor Unit	Colour	White												
	Air flow (H/M/L/SL)	cfm	600/530/430/400	680/600/530/430	860/725/620/530	1030/860/740/620	1200/1030/930/780							
	Sound Level (H/M/L/SL)	dB(A)	34/32/30/28	37/34/33/32	42/38/35/33	47/44/40/36	49/45/43/39							
	Dimensions (HxWxD)	Unit	mm											
		Panel	265x820x820											
	Machine weight	Unit	kg											
		Panel	26											
Certified operation range	Cooling	°CWB												
	Heating	°CDB												
Outdoor Unit	Colour	Light Grey												
	Compressor	Type	Rotary											
		Motor Output (kW)	Cooling	1.79	2.32	2.45	2.58	3.05	4.30					
	Refrigerant charge (R-22)	kg	1.35 (Charged for 7.6 m)	1.50 (Charged for 7.6 m)	1.83 (Charged for 7.6 m)	2.0 (Charged for 7.6 m)	2.60 (Charged for 7.6 m)	2.50 (Charged for 7.6 m)						
		Sound Level	dB(A)	51	52	58								
	Dimensions (HxWxD)	mm	651x855x328		753x855x328		852x1030x400							
	Machine weight	kg	47		57		95		100		105			
Certified operation range	Cooling	°CDB												
	Heating	°CWB												
Piping Connections	Liquid (Flare)	mm	6.35		15.88		19.05							
	Gas (Flare)	mm			15		45							
Max. interunit piping length	m			8		25								
Max. installation level difference	m	8												
Heat insulation	Both Liquid and gas piping													

Note: ¹Rated cooling capacities are based on the following conditions: Indoor temp., 27°CDB, 19°CWB; outdoor temp., 35°CDB. ²Rated heating capacities are based on the following conditions: Indoor temp., 20°CDB; outdoor temp., 7°CDB, 6°CWB. All unit are being tested and comply to ISO 5151 (Non-ducted unit)

CEILING MOUNTED CASSETTE TYPE (Cooling Only)



Model Name	Indoor unit		18		21		26		30		36		42		48			
	Outdoor unit		FHC18NUV1	FHC21NUV1	FHC26NUV1	FHC30NUV1	FHC36NUV1	FHC42NUV1	FHC48NUV1	FHC18NUV1		FHC21NUV1		FHC26NUV1		FHC30NUV1		
Power supply			V1: 1 Phase, 220-240 V, 50 Hz				Y1: 3 Phase, 380-415 V, 50 Hz											
Cooling capacity ^{1a/1b}	Btu/h		18,100/18,000	21,200/21,000	26,300/26,000	30,400/30,000	36,500/36,000	42,700/42,000	49,100/48,000									
	kW		5.3/5.3	6.2/6.2	7.7/7.6	8.9/8.8	10.7/10.6	12.5/12.3	14.1/14.1									
	kcal/h		4,580/4,560	5,340/5,290	6,630/6,550	7,670/7,570	9,200/9,100	10,800/10,600	12,400/12,100									
Power consumption ^{1a/1b}	kW		2.03/2.02	2.46/2.45	3.07/3.07	3.45/3.45	4.04/4.04	4.79/4.79	5.49/5.49									
			White															
Indoor unit	Colour	White																
	Air flow rate (H)	m ³ /min	15	19	28	33												
	Sound level (H/L) (220V) ²	cfm	529	670	988	1,164												
		dB(A)	33/29	35/30	39/34	42/36												
	Dimensions (HxWxD)	Unit	mm															
		Decor. panel	230x840x840															
	Machine weight	Unit	kg															
Decor. panel		24																
Operation range	°CWB																	
Outdoor unit	Colour	Ivory white																
	Compressor	Type	Hermetically sealed rotary type															
		Motor output	kW	1.7	2.2	2.5	3.0	3.75	4.50									
	Refrigerant charge (R-22)	kg	1.20 (Charged for 10m)	1.50 (Charged for 10m)	2.3 (Charged for 10m)	3.0 (Charged for 15m)	3.75 (Charged for 15m)	4.50 (Charged for 15m)										
		Sound level ²	dB(A)	49	54	57	55	57	59									
	Dimensions (HxWxD)	mm	540x750x270		685x800x300		770x900x320		1,170x900x320		1,345x900x320							
	Machine weight	kg	42		61		69		87		92							
Operation range	°CDB																	
Piping connections	Liquid (Flare)	mm	Ø6.4															
	Gas (Flare)	mm	Ø15.9															
	Drain	Indoor unit	mm															
		Outdoor unit	mm															
Max. interunit piping length	m	30 (equivalent length 50m)																
Max. installation level difference	m	15																
Heat insulation	Both liquid and gas piping																	

Notes: ¹ Nominal cooling capacities are based on the following conditions: ^{1a} Return air temp.: 27°CDB, 19.5°CWB, Outdoor temp.: 35°CDB, Equiv. ref. piping: 5m (Horizontal) ^{1b} Return air temp.: 27°CDB, 19.0°CWB, Outdoor temp.: 35°CDB Equiv. ref. piping: 5m (Horizontal) ² Anechoic chamber conversion value, measured under JIS conditions. During actual operation, these values are normally somewhat higher as a result of ambient conditions. Capacities are net, including a deduction for cooling (an addition for heating) for indoor fan motor heat. In case of drain piping for outdoor unit, drain piping kit (option) is needed.

SPECIFICATIONS

CEILING MOUNTED CASSETTE TYPE (Heat Pump)



Model Name	Indoor unit		50		60		71		100		125		140			
	Outdoor unit		FHYC50KVE	FHYC60KVE	FHYC71KVE	FHYC100KVE	FHYC125KVE	FHYC140KVE	FHYC50KVE		FHYC60KVE		FHYC71KVE			
Power supply			V1: 1 Phase, 220-240 V, 50 Hz				Y1: 3 Phase, 380-415 V, 50 Hz									
Cooling capacity ^{1a/1b}	Btu/h		18,000/17,800	21,300/21,000	26,600/26,200	35,700/35,300	44,500/43,600	49,400/48,400								
	kW		5.27/5.2	6.24/6.15	7.8/7.7	10.5/10.4	13.0/12.8	14.5/14.2								
	kcal/h		4,530/4,470	5,370/5,290	6,700/6,600	9,000/8,900	11,200/11,000	12,500/12,200								
Heating capacity ²	Btu/h		19,800	23,900	27,000	38,100	48,400	56,000								
	kW		5.8	7.0	7.9	11.2	14.2	16.3								
	kcal/h		4,990	6,020	6,800	9,600	12,200	14,000								
Power consumption	Cooling ^{1a/1b}	kW	1.92/1.91	2.35/2.33	2.99/2.99	3.88/3.88	4.89/4.89	4.95/4.95								
	Heating ²	kW	1.68	2.26	2.82	3.60	4.68	4.84								
Indoor unit	Colour	White														
	Air flow rate (H)	m ³ /min	15	19	28	33	35									
	Sound level (H/L) ³	cfm	529	670	988	1,164	1,235									
		dB(A)	33/29	35/30	39/34	42/36	44/37									
	Dimensions (HxWxD)	Unit	mm													
		Decor. panel	230x840x840													
	Machine weight	Unit	kg													
Decor. panel		24														
Certified operation range	Cooling	°CWB														
	Heating	°CDB														
Outdoor unit	Colour	Ivory white														
	Compressor	Type	Hermetically sealed rotary type													
		Motor output	kW	1.7	2.2	2.24	3.00	3.75	4.50							
	Refrigerant charge (R-22)	kg	1.55 (Charged for 10m)	1.75 (Charged for 5m)	2.8 (Charged for 30m)	3.7 (Charged for 30m)	4.1 (Charged for 30m)									
		Sound level (Cooling/Heating) ³	dB(A)	49/51	54/54	48/49	49/52	54/56								
	Dimensions (HxWxD)	mm	685x800x300		685x880x350		770x900x320		1,170x900x320		1,345x900x320					
	Machine weight	kg	51		75		72		86		101		112			
Certified operation range	Cooling	°CWB														
	Heating	°CDB														
Piping connections	Liquid (Flare)	mm	Ø6.4													
	Gas (Flare)	mm	Ø15.9													
	Drain	Indoor unit	mm													
		Outdoor unit	mm													
Max. interunit piping length	m	30														
Max. installation level difference	m	15														
Heat insulation	Both liquid and gas piping															

Note: ¹Rated cooling capacities are based on the following conditions: ^{1a} Indoor temp., 27°CDB, 19.5°CWB; outdoor temp., 35°CDB, Equiv. refrigeration piping, 5m (horizontal). ^{1b} Indoor temp., 27°CDB, 19.0°CWB; outdoor temp., 35°CDB, Equiv. refrigeration piping, 5m (horizontal) (RY71LU-RY140LU is 7.5m). ²Rated heating capacities are based on the following conditions: Indoor temp., 20°CDB; outdoor temp., 7°CDB, 6°CWB, Equiv. refrigeration piping, 5m (horizontal) (RY71LU-RY140LU is 7.5m). ³ Anechoic chamber conversion value, measured according to JIS parameters and criteria. During operation these values are somewhat higher owing to ambient conditions.

CEILING SUSPENDED CASSETTE TYPE (Cooling Only)



Model Name	Indoor unit		71		100		125			
	Outdoor unit		FUY71FJV1	FUY100FJV1	FUY125FJV1	FUY71FJV1		FUY125FJV1		
Power supply			3 Phase, 380-415 V, 50 Hz							
Cooling capacity ^{1a/1b}	Btu/h		26,600/26,200	36,100/35,700	44,500/43,600					
	kW		7.8/7.7	10.6/10.5	13.0/12.8					
	kcal/h		6,700/6,600	9,100/9,000	11,200/11,000					
Power consumption ^{1a/1b}	kW		3.06/3.06	4.02/4.02	4.97/4.97					
Indoor unit	Colour	White								
	Air flow rate (H)	m ³ /min	19	29	32					
	Sound level (H/L) ²	cfm	670	1,023	1,129					
		dB(A)	40/35	43/38	44/39					
	Dimensions (HxWxD)	Unit	mm							
		Decor. panel	165x895x895							
	Machine weight	Unit	kg							
Decor. panel		25								
Operation range	°CWB									
Outdoor unit	Colour	Ivory white								
	Compressor	Type	Hermetically sealed scroll type							
		Motor output	kW	2.8 (Charged for 30m)	3.7 (Charged for 30m)	4.9 (Charged for 30m)				
	Refrigerant charge (R-22)	kg	2.8 (Charged for 30m)	3.7 (Charged for 30m)	4.9 (Charged for 30m)					
		Sound level ²	dB(A)	48	49	49				
	Dimensions (HxWxD)	mm	770x900x320		1,170x900x320		1,345x900x320			
	Machine weight	kg	71		84		98			
Operation range	°CDB									
Piping connections	Liquid (Flare)	mm	Ø6.4							
	Gas (Flare)	mm	Ø15.9							
	Drain	Indoor unit	mm							
		Outdoor unit	mm							
Max. interunit piping length	m	50 (equivalent length 70m)								
Max. installation level difference	m	30								
Heat insulation	Both liquid and gas piping									

Note: Shows net capacities when cooling it is the value minus the heat of the indoor unit fan motor. ¹ Nominal cooling capacities are based on the following conditions: ^{1a} Return air temp.: 27°CDB, 19.5°CWB, Outdoor temp.: 35°CDB, Equiv. refrigeration piping: 5m (Horizontal). ^{1b} Return air temp.: 27°CDB, 19.0°CWB, Outdoor temp.: 35°CDB, Equiv. refrigeration piping: 5m (Horizontal), (R71-R125 is 7.5m). ² Anechoic chamber conversion value, measured according to JIS parameters and criteria. During operation these values are somewhat higher owing to ambient conditions.

SPECIFICATIONS

WALL MOUNTED TYPE (Cooling Only)

R-22

Model Name	Indoor unit		71		100		
	Outdoor unit		FAY71LVE		FAY100FAVE		
Power supply			3 Phase, 380-415 V, 50 Hz				
Cooling capacity ^{1a/1b}	kW		7.8/7.7		10.6/10.5		
	Btu/h		26,600/26,200		36,100/35,700		
	kcal/h		6,700/6,600		9,100/9,000		
Power consumption ^{1a/1b}	kW		2.96/2.96		3.85/3.85		
Indoor unit	Colour		White				
	Air flow rate (H)		m ³ /min		23		
			cfm		811		
	Sound level (H/L) ²		dB(A)		43/37		
	Dimensions (HxWxD)		mm		290X1,050X230		
	Machine weight		kg		26		
	Operation range		°CWB		14 to 25		
Outdoor unit	Colour		Ivory white				
	Compressor	Type	Hermetically sealed scroll type				
	Refrigerant charge (R-22)		kg		2.8 (Charged for 30m)		
	Sound level ²		dB(A)		48		
	Dimensions (HxWxD)		mm		770X900X320		
	Machine weight		kg		84		
	Operation range		°CDB		21 to 46		
Piping connections	Liquid (Flare)	mm	Ø9.5				
	Gas (Flare)	mm	Ø15.9		Ø19.1		
	Drain	Indoor unit	mm	I.D.Ø13XO.D.Ø18		I.D.Ø20XO.D.Ø26	
		Outdoor unit	mm	Ø26.0 (Hole)			
Max. interunit piping length		m		50 (equivalent length 70m)			
Max. installation level difference		m		30			
Heat insulation		Both liquid and gas piping					

Note: ¹ Nominal cooling capacities are based on the following conditions: ^{1a} Return air temp.: 27°CDB, 19.5°CWB, Outdoor temp.: 35°CDB Equiv. refrigeration piping: 5m (Horizontal), ^{1b} Return air temp.: 27°CDB, 19.0°CWB, Outdoor temp.: 35°CDB Equiv. refrigeration piping: 5m (Horizontal), ² Anechoic chamber conversion value, measured according to JIS parameters and criteria. During actual operation these values are somewhat higher owing to ambient conditions. Capacities are net, including a deduction for cooling (an addition for heating) for indoor fan motor heat. In case of drain piping for outdoor unit, drain piping kit (option) is needed.

SPECIFICATIONS

CEILING SUSPENDED TYPE (Heat Pump)

R-22

Model Name	Indoor unit		50		60		71		100		125		
	Outdoor unit		FHY50BVE		FHY60BVE		FHY71BVE		FHY100BVE		FHY125BVE		
Power supply			1 Phase 220-240/220 V, 50/60 Hz				3 Phase, 380-415 V, 50 Hz						
Cooling capacity ^{1a/1b}	kW		5.0/4.85		6.3/6.15		7.8/7.7		10.5/10.4		13.0/12.8		
	Btu/h		16,900/16,600		21,400/21,000		26,600/26,200		35,700/35,300		44,500/43,600		
	kcal/h		4,260/4,200		5,390/5,300		6,700/6,600		9,000/8,900		11,200/11,000		
Heating capacity ²	kW		5.5		7.1		7.9		11.2		14.2		
	Btu/h		18,800		24,200		27,000		38,100		48,400		
	kcal/h		4,750		6,100		6,800		9,600		12,200		
Power consumption	Cooling ^{1a/1b}		kW		2.17/2.16		3.14/3.12		3.02/3.02		3.77/3.77		
	Heating ²		kW		1.96		2.94		2.95		3.64		
Indoor unit	Colour		White										
	Airflow rate (H)		m ³ /min		13		16		17		24		
			cfm		458		564		600		847		
	Sound level (H/L) ³		dB(A)		38/33		39/35		42/37		44/39		
	Dimensions (HxWxD)		mm		195x960x680		195x1,160x680		195x1,400x680		195x1,590x680		
	Machine weight		kg		24		26		27		35		
	Certified operation range	Cooling	°CWB		14 to 23		12 to 25		15 to 27				
Heating		°CDB		15 to 28									
Outdoor unit	Colour		Ivory white										
	Compressor	Type	Hermetically sealed rotary type				Hermetically sealed scroll type						
	Refrigerant charge (R-22)		kg		1.7		2.2		2.24		3.00		
	Sound level ²		dB(A)		1.55		1.75		2.8		3.7		
	Dimensions (HxWxD)		mm		49/51		54/54		48/49		49/52		
	Machine weight		kg		51		75		72		86		
	Certified operation range	Cooling	°CDB		19.4 to 46		-5 to 46		-10 to 15				
Heating		°CWB		-10 to 15.5									
Piping connections	Liquid (Flare)	mm	Ø6.4		Ø15.9		Ø9.5		Ø19.1				
	Gas (Flare)	mm	Ø15.9		Ø18.0 (Hole)		Ø26.0 (Hole)		Ø19.1				
	Drain	Indoor unit	mm	I.D.Ø20XO.D.Ø26				Ø26.0 (Hole)					
		Outdoor unit	mm	Ø18.0 (Hole)				Ø26.0 (Hole)					
Max. interunit piping length		m		30		50 (equivalent length 70 m)							
Max. installation level difference		m		15		30							
Heat insulation		Both liquid and gas piping											

Note: ¹ Rated cooling capacities are based on the following conditions: ^{1a} Indoor temp.: 27°CDB, 19.5°CWB; outdoor temp.: 35°CDB, Equiv. refrigeration piping: 5m (horizontal), ^{1b} Indoor temp.: 27°CDB, 19.0°CWB; outdoor temp.: 35°CDB, Equiv. refrigeration piping: 5m (horizontal), (RY71LU-RY140LU is 7.5m) ² Rated heating capacities are based on the following conditions: Indoor temp.: 20°CDB; Outdoor temp.: 7°CDB, 6°CWB, Equiv. refrigeration piping: 5m (horizontal), (RY71LU-RY140LU is 7.5m) ³ Anechoic chamber conversion value, measured according to JIS parameters and criteria. During actual operation these values are somewhat higher owing to ambient conditions. ⁴ In case of v1: 220V, Y1: 380V.

CEILING SUSPENDED TYPE (Cooling Only)

R-22

Model Name	Indoor unit		21		26		30		36		42		48		
	Outdoor unit		FH21NUV1		FH26NUV1		FH30NUV1		FH36NUV1		FH42NUV1		FH48NUV1		
Power supply			V1: 1 Phase, 220-240 V, 50 Hz				Y1: 3 Phase, 380-415 V, 50 Hz								
Cooling capacity ^{1a/1b}	Btu/h		21,200/21,000		26,300/26,000		30,400/30,000		36,500/36,000		42,700/42,000		49,100/48,000		
	kW		6.2/6.2		7.7/7.6		8.9/8.8		10.7/10.6		12.5/12.3		14.4/14.1		
	kcal/h		5,340/5,290		6,630/6,550		7,670/7,570		9,200/9,100		10,800/10,600		12,400/12,100		
Power consumption ^{1a/1b}	kW		2.72/2.71		3.10/3.10		3.48/3.48		4.06/4.06		4.83/4.83		5.50/5.50		
Indoor unit	Colour		White												
	Airflow rate (H)		m ³ /min		22-23		26-27		32-34		38-40		42-44		
			cfm		776-811		918-953		1,129-1,200		1,341-1,412		1,482-1,553		
	Sound level (H/L) (220V) ²		dB(A)		44/40		45/40		46/40		48/42		49/43		
	Dimensions (HxWxD)		mm		195X1,160X680		195X1,400X680		195X1,590X680						
	Machine weight		kg		26		32		35						
	Operation range		°CWB		14 to 28										
Outdoor unit	Colour		Ivory white		Ivory		Ivory		Ivory		Ivory		Ivory		
	Compressor	Type	Hermetically sealed rotary type												
	Refrigerant charge (R-22)		kg		2.2		2.5		3.00		3.75		4.50		
	Sound level ^{2,3}		dB(A)		1.50		2.3		2.0		2.4		2.6		
	Dimensions (HxWxD)		mm		685X800X300		770X900X320		1,170X900X320		1,345X900X320				
	Machine weight		kg		61		69		79		87		92		
	Operation range		°CDB		21 to 46										
Piping connections	Liquid (Flare)	mm	Ø6.4		Ø9.5		Ø19.1								
	Gas (Flare)	mm	Ø15.9		Ø18.0 (Hole)		Ø26.0 (Hole)								
	Drain	Indoor unit	mm	I.D.Ø20XO.D.Ø26				Ø26.0 (Hole)							
		Outdoor unit	mm	Ø18.0 (Hole)		Ø26.0 (Hole)									
Max. interunit piping length		m		30 (equivalent length 50 m)		20									
Max. installation level difference		m		15		20									
Heat insulation		Both liquid and gas piping													

Note: ¹ Rated cooling capacities are based on the following conditions: ^{1a} Indoor temp.: 27°CDB, 19.5°CWB; outdoor temp.: 35°CDB, Equiv. refrigeration piping: 7.5m (horizontal), ^{1b} Indoor temp.: 27°CDB, 19.0°CWB; outdoor temp.: 35°CDB, Equiv. refrigeration piping: 7.5m (horizontal), ² Anechoic chamber conversion value, measured according to JIS parameters and criteria. During actual operation these values are somewhat higher owing to ambient conditions. ³ In case of v1: 220V, Y1: 380V.

FLOOR STANDING TYPE (Cooling Only)

R-22

Model Name	Indoor unit		71		100		125		
	Outdoor unit		FVY71LAVE		FVY100LAVE		FVY125LAVE		
Power supply			3 Phase, 380-415 V, 50 Hz						
Cooling capacity ^{1a/1b}	kW		7.8/7.7		10.6/10.5		13.0/12.8		
	Btu/h		26,600/26,200		36,100/35,700		44,500/43,600		
	kcal/h		6,700/6,600		9,100/9,000		11,200/11,000		
Power consumption ^{1a/1b}	kW		3.18/3.16		4.03/3.98		5.06/5.06		
Indoor unit	Colour		White						
	Air flow rate (H)		m ³ /min		18		28		
			cfm		635		988		
	Sound level (H/L) ²		dB(A)		41/35		46/40		
	Dimensions (HxWxD)		mm		1,850X600X270		1,850X600X350		
	Machine weight		kg		39		46		
	Operation range		°CWB		14 to 25		14 to 25		
Outdoor unit	Colour		Ivory white						
	Compressor	Type	Hermetically sealed scroll type						
	Refrigerant charge (R-22)		kg		2.8 (Charged for 30m)		3.7 (Charged for 30m)		
	Sound level ²		dB(A)		48		49		
	Dimensions (HxWxD)		mm		770X900X320		1,170X900X320		
	Machine weight		kg		71		84		
	Operation range		°CDB		21 to 46		21 to 46		
Piping connections	Liquid (Flare)	mm	Ø6.4		Ø9.5		Ø19.1		
	Gas (Flare)	mm	Ø15.9		Ø18.0 (Hole)		Ø26.0 (Hole)		
	Drain	Indoor unit	mm	I.D.Ø20XO.D.Ø26				Ø26.0 (Hole)	
		Outdoor unit	mm	Ø18.0 (Hole)		Ø26.0 (Hole)			
Max. interunit piping length		m		50 (equivalent length 70m)		30			
Max. installation level difference		m		15		20			
Heat insulation		Both liquid and gas piping							

Note: Shows net capacities. When cooling it is the value minus the heat of the indoor unit fan motor. ¹ Nominal cooling capacities are based on the following conditions: ^{1a} Return air temp.: 27°CDB, 19.5°CWB, Outdoor temp.: 35°CDB Equiv. refrigeration piping: 5m (Horizontal), ^{1b} Return air temp.: 27°CDB, 19.0°CWB, Outdoor temp.: 35°CDB Equiv. refrigeration piping: 5m (Horizontal), (R71-R140 is 7.5m) ² Anechoic chamber conversion value, measured according to JIS parameters and criteria. During actual operation these values are somewhat higher owing to ambient conditions.

SPECIFICATIONS

DUCT CONNECTION LOW STATIC PRESSURE TYPE (Cooling Only)

R-22

Model Name		25		35		50		60		71				
Indoor unit		FDB25KVE		FDB35KVE		FDB50KVE		FDB60KVE		FDB71KVE				
Outdoor unit		R25GV1		R35GV1		R50GV1		R60GV1		R71FU1				
Power supply		1 Phase, 220-240 V, 50 Hz												
Cooling capacity ^{1a/1b}		kW		2.64/2.60		3.54/3.50		5.34/5.30		6.44/6.40				
		Btu/h		9,000/8,900		12,100/11,900		18,200/18,100		22,000/21,800				
		kcal/h		2,270/2,250		3,040/3,010		4,590/4,560		5,540/5,500				
Power consumption ^{1a/1b}		kW		0.87/0.86		1.25/1.24		2.06/2.05		2.76/2.75				
Indoor unit	Air flow rate (H)		m ³ /min		13		18		18		18			
			cfm		458		635		635		635			
	Fan	External static pressure		Pa (mmH ₂ O)		20(2)		20(2)		20(2)		20(2)		
		Driving system		Direct drive (2 speed)										
	Sound level (H/L) ²		dB(A)		41/38		43/40		43/40		43/40			
	Dimensions (HxWxD)		mm		260x900x580		260x900x580		260x1300x580		260x1300x580			
	Machine weight		kg		22		23		31		31			
	Operation range		°CWB		14 to 23		14 to 23		14 to 25		14 to 25			
	Colour		Ivory white											
	Compressor		Type		Hermetically sealed rotary type									
Outdoor unit	Refrigerant charge (R-22)		kg		0.76 (Charged for 10 m)		1.10 (Charged for 10 m)		1.20 (Charged for 10 m)		1.50 (Charged for 5 m)			
	Sound level ²		dB(A)		45		48		49		52			
	Dimensions (HxWxD)		mm		550x695x245		540x750x270		685x800x300		816x880x370			
	Machine weight		kg		29		37		42		84			
	Operation range		°CDB		19.4 to 46		19.4 to 54		19.4 to 46		21 to 52			
	Piping connections	Liquid (Flare)		mm		Ø9.5		Ø12.7		Ø15.9		Ø9.5		
		Gas (Flare)		mm		Ø9.5		Ø12.7		Ø15.9		Ø9.5		
		Drain	Indoor unit		mm		Ø18.0 (Hole)		Ø18.0 (Hole)		Ø26.0 (Hole)		Ø26.0 (Hole)	
			Outdoor unit		mm		Ø18.0 (Hole)		Ø18.0 (Hole)		Ø26.0 (Hole)		Ø26.0 (Hole)	
	Max. interunit piping length		m		25		30		30		50 (Equivalent Length 70 m)			
Max. installation level difference		m		15		15		15		30				
Heat insulation		Both liquid and gas piping												

Note: Shows net capacities. When cooling it is the value minus the heat of the indoor unit fan motor.
^{1a} Nominal cooling capacities are based on the following conditions: ^{1a} Return air temp.: 27°CDB, 19.5°CWB, Outdoor temp.: 35°CDB Equiv. refrigeration piping: 5m (Horizontal).
^{1b} Return air temp.: 27°CDB, 19.0°CWB, Outdoor temp.: 35°CDB Equiv. refrigeration piping: 5m (Horizontal), (R71-R125 is 7.5m)
² Anechoic chamber conversion value, measured according to JIS parameters and criteria. During actual operation these values are somewhat higher owing to ambient conditions.

DUCT CONNECTION LOW STATIC PRESSURE TYPE (Heat Pump)

R-22

Model Name		35		50		60		71						
Indoor unit		FDYB35KAVE		FDYB50KAVE		FDYB60KAVE		FDYB71KAVE						
Outdoor unit		RY35FV1A		RY50GAV1A		RY60GAV1A		RY71LUY1						
Power supply		1 Phase, 220-240 V, 50 Hz												
Cooling capacity ^{1a/1b}		kW		3.79/3.75		5.27/5.20		6.24/6.15		7.87/7.7				
		Btu/h		12,900/12,800		18,000/17,800		21,300/21,000		26,600/26,200				
		kcal/h		3,260/3,230		4,530/4,470		5,370/5,290		6,700/6,600				
Heating capacity ²		kW		4.22		5.80		7.0		7.9				
		Btu/h		14,400		19,800		23,900		27,000				
		kcal/h		3,630		4,990		6,020		6,800				
Power consumption		Cooling ^{1a/1b}		kW		1.51/1.50		2.01/2.00		2.38/2.36				
		Heating ²		kW		1.33		1.78		2.29				
Indoor unit	Airflow rate (H)		m ³ /min		13		18		18		18			
			cfm		460		635		635		635			
	Fan	External static pressure		Pa (mmH ₂ O)		20 (2)		20 (2)		20 (2)		20 (2)		
		Driving system		Direct drive (2 speed)										
	Sound level (H/L) ³		dB(A)		41/38		43/40		43/40		43/40			
	Dimensions (HxWxD)		mm		260x900x580		260x900x580		260x1300x580		260x1300x580			
	Machine weight		kg		22		23		31		31			
	Certified operation range		Cooling		°CDB		14 to 23		14 to 23		12 to 25			
			Heating		°CDB		15 to 28		15 to 28		15 to 27			
	Colour		Ivory white											
Outdoor unit	Compressor		Type		Hermetically sealed rotary type									
			Motor output		kW		1.3		1.7		2.2			
	Refrigerant charge (R-22)		kg		1.12 (Charged for 10 m)		1.55 (Charged for 10 m)		1.75 (Charged for 5 m)		2.8 (Charged for 30 m)			
	Sound level (Cooling/Heating) ³		dB(A)		47/48		49/51		54/54		48/49			
	Dimensions (HxWxD)		mm		540x750x270		685x800x300		685x800x350		770x900x320			
	Machine weight		kg		41		51		75		72			
	Certified operation range		Cooling		°CDB		19.4 to 46		19.4 to 46		-5 to 44			
			Heating		°CWB		-10 to 15.5		-10 to 15.5		-10 to 15			
	Piping connections	Liquid (Flare)		mm		Ø12.7		Ø6.4		Ø15.9		Ø9.5		
		Gas (Flare)		mm		Ø12.7		Ø6.4		Ø15.9		Ø9.5		
Drain		Indoor unit		mm		Ø18.0 (Hole)		Ø18.0 (Hole)		Ø26.0 (Hole)		Ø26.0 (Hole)		
		Outdoor unit		mm		Ø18.0 (Hole)		Ø18.0 (Hole)		Ø26.0 (Hole)		Ø26.0 (Hole)		
Max. interunit piping length		m		20		30		30		50 (Equivalent Length 70m)				
Max. installation level difference		m		15		15		15		30				
Heat insulation		Both liquid and gas piping												

Note: ¹ Rated cooling capacities are based on the following conditions: (FDYB) ^{1a} Suction temp.: 27°CDB, 19.5°CWB, Outdoor temp.: 35°CDB Equiv. refrigeration piping: 5m (Horizontal).
^{1b} Suction temp.: 27°CDB, 19.0°CWB, Outdoor temp.: 35°CDB Equiv. refrigeration piping: 5m (Horizontal).
² Rated heating capacities are based on the following conditions: (FDYB) Suction temp.: 20°CDB, Outdoor temp.: 7°CDB, 6°CWB, Equiv. refrigeration piping: 5m (Horizontal).
³ Anechoic chamber conversion value, measured according to JIS parameters and criteria. During operation these values are somewhat higher owing to ambient conditions.

SPECIFICATIONS

DUCT CONNECTION MIDDLE STATIC PRESSURE TYPE (Cooling Only)

R-22

Model Name		26		30		36		42		48		51		56					
Indoor unit		FDMG26NUV1		FDMG30NUV1		FDMG36NUV1		FDMG42NUV1		FDMG48NUV1		FDMG51NUV1		FDMG56NUV1					
Outdoor unit		R26NUY1		R30NUY1		R36NUY1		R42NUY1		R48NUY1		R51NUY1		R56NUY1					
Power supply		3 Phase, 380-415 V, 50 Hz																	
Cooling capacity ¹		Btu/h		26,000		30,000		36,000		42,000		48,000		51,000		56,000			
		kW		7.6		8.8		10.6		12.3		14.1		15.0		16.4			
		kcal/h		6,550		7,570		9,100		10,600		12,100		12,900		14,100			
Power consumption ¹		kW		3.15		3.46		4.16		4.84		5.55		5.90		6.45			
Indoor unit	Fan	Airflow rate (H)		m ³ /min		23		34		37		42		48		58			
				cfm		811		1,200		1,306		1,482		1,700		2,000			
	Sound level (H/L) (220V) ²		dB(A)		42/38		44/36		45/37		46/37		47/37		47/37				
	Dimensions (HxWxD)		mm		305x1,350x680		305x1,350x680		305x1,550x680		305x1,550x680		305x1,900x680		305x1,900x680				
	Machine weight		kg		43		51		52		58		58		58				
	Certified operation range		°CWB		14 to 25		14 to 25		14 to 25		14 to 25		14 to 25		14 to 25				
	Colour		Ivory																
	Outdoor unit	Compressor		Type		Hermetically sealed rotary type													
				Motor output		kW		2.5		3.00		3.75		4.50		4.50		4.50	
		Refrigerant charge (R-22)		kg		2.3 (Charged for 10 m)		2.0 (Charged for 5m)		2.4 (Charged for 5m)		2.6 (Charged for 5m)		2.7 (Charged for 5m)		2.8 (Charged for 5m)			
Sound level ²		dB(A)		57		55		57		59		59		56					
Dimensions (HxWxD)		mm		770x900x320		770x900x320		1,170x900x320		1,345x900x320		1,345x900x320		1,345x880x370					
Machine weight		kg		69		79		87		92		93		114					
Certified operation range		°CDB		21 to 46		21 to 46		21 to 46		21 to 46		21 to 46		21 to 46					
Piping connections	Liquid (Flare)		mm		Ø15.9		Ø15.9		Ø19.1		Ø19.1		Ø19.1		Ø19.1				
	Gas (Flare)		mm		Ø15.9		Ø15.9		Ø19.1		Ø19.1		Ø19.1		Ø19.1				
	Drain	Indoor unit		mm		Ø18.0 (Hole)		Ø18.0 (Hole)		Ø26.0 (Hole)		Ø26.0 (Hole)		Ø26.0 (Hole)		Ø26.0 (Hole)			
Outdoor unit		mm		Ø18.0 (Hole)		Ø18.0 (Hole)		Ø26.0 (Hole)		Ø26.0 (Hole)		Ø26.0 (Hole)		Ø26.0 (Hole)					
Max. interunit piping length		m		30 (equivalent length 50m)		30 (equivalent length 50m)		30 (equivalent length 50m)		30 (equivalent length 70m)		30 (equivalent length 70m)		50 (equivalent length 70m)					
Max. installation level difference		m		20		20		20		20		20		30					
Heat insulation		Both liquid and gas piping																	

Note: ¹ Rated cooling capacities are based on the following conditions: Suction temp.: 27°CDB, 19.0°CWB, Outdoor temp.: 35°CDB Equiv. refrigeration piping: 7.5m (Horizontal).
² Anechoic chamber conversion value, measured according to JIS parameters and criteria.
³ During operation these values are somewhat higher owing to ambient conditions.

DUCT CONNECTION MIDDLE STATIC PRESSURE TYPE (Heat Pump)

R-22

Model Name		71		100		125		140										
Indoor unit		FDYM03FAV1		FDYM04FAV1		FDYM05FAV1		FDYM06FAV1										
Outdoor unit		RY71LUY1		RY100LUY1		RY125LUY1		RY140LUY1										
Power supply		3 Phase, 380-415 V, 50 Hz																
Cooling capacity ^{1a/1b}		kW		7.8/7.7		10.5/10.4		13.0/12.8		14.5/14.2								
		Btu/h		26,600/26,200		35,700/35,300		44,500/43,600		49,400/48,400								
		kcal/h		6,700/6,600		9,000/8,900		11,200/11,000		12,500/12,200								
Heating capacity ²		kW		7.9		11.2		14.2		16.3								
		Btu/h		27,000		38,100		48,400		56,000								
		kcal/h		6,800		9,600		12,200		14,000								
Power consumption		Cooling ^{1a/1b}		kW		3.17/3.17		3.95/3.95		4.99/4.99								
		Heating ²		kW		2.92		3.86		4.75								
Indoor unit	Fan	Airflow rate (H/L)		m ³ /min		20		26		35		37						
				cfm		706		917		1,235		1,306						
	External static pressure		Pa (mmH ₂ O)		706		917		1,235		1,306		1,306					
	Sound level (H) ³		dB(A)		39		44		44		46		46					
	Dimensions (HxWxD)		mm		295x1,100x680		295x1,100x680		295x1,500x680		295x1,500x680		295x1,500x680					
	Machine weight		kg		42		56		57		57		57					
	Certified operation range		Cooling		°CWB		12 to 25		12 to 25		15 to 27		15 to 27					
			Heating		°CDB		15 to 27		15 to 27		15 to 27		15 to 27					
	Colour		Ivory white															
	Outdoor unit	Compressor		Type		Hermetically sealed scroll type												
		Motor output		kW		2.24		3.00		3.75		4.50		4.50				
Refrigerant charge (R-22)		kg		2.8 (Charged for 30 m)		3.7 (Charged for 30 m)		3.7 (Charged for 30 m)		4.1 (Charged for 30 m)		4.1 (Charged for						

SPECIFICATIONS

COMPACT MULTI FLOW CEILING MOUNTED CASSETTE TYPE (Cooling Only)



Model Name		25	35	50	60
Indoor unit		FFQ25BV1B	FFQ35BV1B	FFQ50BV1B	FFQ60BV1B
Outdoor unit		RXS25EVMA	RXS35EVMA	RXS50FVMA	RXS60FVMA
Power supply		1 Phase, 220-240 V, 50 Hz			
Cooling capacity ¹ Rated (Min. - Max.)	kW	2.5 (1.2-3.0)	3.4 (1.2-3.7)	4.7 (1.7-5.6)	5.8 (1.7-6.0)
Power consumption	kW	0.73	1.10	1.62	2.065
Indoor unit		White			
Airflow rate (H)	ℓ/s	150/108	167/108	200/133	250/167
	m ³ /min	9/6.5	10/6.5	12/8	15/10
Sound level (H/L) ²	dB(A)	29.5/24.5	32/25	36/27	41/32
Sound power ³	dB(A)	46.5	49	53	58
Dimensions (HxWxD)	Unit	286X575X575			
	Decoration panel	55X700X700			
Machine weight	Unit	17.5			
	Decoration panel	2.7			
Certified operation range	CWB	14 to 28			
Outdoor unit		Ivory white			
Compressor	Type	Hermetically sealed swing type			
	Motor output	kW			
Refrigerant charge (R-410A)	kg	0.6 (Charged for 10 m)	1.0 (Charged for 10 m)	1.1 (Charged for 10 m)	1.5 (Charged for 10 m)
Sound level ²	dB(A)	46	47	49	49
Sound power ³	dB(A)	62	61	63	63
Dimensions (HxWxD)	mm	550X765X285		735X825X300	
Machine weight	kg	34		47	
Certified operation range	CDB	10 to 46			
Piping connections	Liquid (Flare)	mm			
	Gas (Flare)	mm			
	Drain	mm			
Max. interunit piping length	m	20		30	
Max. installation level difference	m	15		20	
Heat insulation		Both liquid and gas piping			

Note: ¹ Rated cooling capacities are based on the following conditions: Indoor temp., 27°CDB, 19.0°CWB; outdoor temp., 35°CDB, Equiv. refrigeration piping: 7.5 m (horizontal).
² Anaechoic chamber conversion value, measured according to JIS parameters and criteria. During operation these values are somewhat higher owing to ambient conditions.
³ Numerical values are according to ISO 3741:1999.

SPECIFICATIONS

ROUND FLOW CEILING MOUNTED CASSETTE TYPE (Cooling Only)



Model Name		50	60	71	100	125	140	100	125	140	
Indoor unit		FCQ50LUV1	FCQ60LUV1	FCQ71LUV1	FCQ100LUV1	FCQ125LUV1	FCQ140LUV1	FCQ100LUV1	FCQ125LUV1	FCQ140LUV1	
Outdoor unit		RZR50LUV1	RZR60LUV1	RZR71LUV1	RZR100LUV1	RZR125LUV1	RZR140LUV1	RZR100LUV1	RZR125LUV1	RZR140LUV1	
Power supply		1Phase,220-240V,50Hz					3Phase,380-415V,50Hz				
Cooling capacity ¹ Rated (Min. - Max.)	kW	5.0 (2.3-5.6)	6.0 (2.6-6.3)	7.1 (3.2-8.0)	10.0 (5.0-11.2)	12.5 (5.7-14.0)	14.0 (6.2-15.4)	10.0 (5.0-11.2)	12.5 (5.7-14.0)	14.0 (6.2-15.4)	
Power consumption	kW	1.30	1.62	1.99	2.78	3.68	4.91	2.78	3.68	4.91	
Indoor unit		Fresh white									
Airflow rate (H/L)	Unit	m ³ /min									
	Decomposition panel	mm									
Sound level (H/L) ²	Unit	dB(A)									
	Decomposition panel	mm									
Dimensions (HxWxD)	Unit	mm									
	Decomposition panel	mm									
Machine weight	Unit	kg									
	Decomposition panel	kg									
Certified Operation range	Cooling	°CWB									
Outdoor unit		Ivory white									
Compressor	Type	Hermetically sealed swing type			Hermetically sealed scroll type						
	Motor output	kW									
Refrigerant charge (R-410A)	kg	1.6 (Charged for 30 m)	3.35 (Charged for 30 m)	3.7 (Charged for 30 m)	2.7 (Charged for 30 m)	3.7 (Charged for 30 m)	2.7 (Charged for 30 m)	3.7 (Charged for 30 m)	2.7 (Charged for 30 m)	3.7 (Charged for 30 m)	
Sound level ²	Cooling	dB(A)									
	Night quiet mode	dB(A)									
Dimensions (HxWxD)	mm	595x845x300			990x940x320						
Machine weight	kg	43			97						
Certified Operation range	Cooling	°CDB									
Piping connections	Liquid (Flare)	mm									
	Gas (Flare)	mm									
	Drain	mm									
Max. interunit piping length	m	50 (Equivalent length 70)									
Max. installation level difference	m	30									
Heat insulation		Both liquid and gas piping									

Note: ¹ Rated cooling capacities are based on the following conditions: Indoor temp., 27°CDB, 19.0°CWB; outdoor temp., 35°CDB, 24°CWB, Equiv. refrigeration piping: 7.5 m (horizontal).
² Anaechoic chamber conversion value, measured according to JIS parameters and criteria. During operation these values are somewhat higher owing to ambient conditions.

COMPACT MULTI FLOW CEILING MOUNTED CASSETTE TYPE (Heat Pump)



Model Name		25	35	50	60
Indoor unit		FFQ25BV1B	FFQ35BV1B	FFQ50BV1B	FFQ60BV1B
Outdoor unit		RXS25EVMA	RXS35EVMA	RXS50FVMA	RXS60FVMA
Power supply		1 Phase, 220-240 V, 50 Hz			
Cooling capacity ¹ Rated (Min. - Max.)	kW	2.5 (1.2-3.0)	3.4 (1.2-3.7)	4.7 (1.7-5.6)	5.8 (1.7-6.0)
Heating capacity ² Rated (Min. - Max.)	kW	3.2 (1.2-4.5)	4.0 (1.2-5.0)	5.5 (1.7-7.0)	7.0 (1.7-8.0)
Power consumption	kW	0.73	1.10	1.62	2.065
Indoor unit		White			
Airflow rate (H)	ℓ/s	150/108	167/108	200/133	250/167
	m ³ /min	9/6.5	10/6.5	12/8	15/10
Sound level (H/L) ³	dB(A)	29.5/24.5	32/25	36/27	41/32
Sound power ⁴	dB(A)	46.5	49	53	58
Dimensions (HxWxD)	Unit	286X575X575			
	Decoration panel	55X700X700			
Machine weight	Unit	17.5			
	Decoration panel	2.7			
Certified operation range	CWB	14 to 28			
Outdoor unit		Ivory white			
Compressor	Type	Hermetically sealed swing type			
	Motor output	kW			
Refrigerant charge (R-410A)	kg	0.6 (Charged for 10 m)	1.0 (Charged for 10 m)	1.1 (Charged for 10 m)	1.5 (Charged for 10 m)
Sound level	dB(A)	46/47	47/48	49/49	49/49
Sound power	dB(A)	61/62	62/63	61/62	63/63
Dimensions (HxWxD)	mm	550X765X285		735X825X300	
Machine weight	kg	34		48	
Certified operation range	CDB	10 to 46			
Operation range	CWB	-10 to 20			
Piping connections	Liquid (Flare)	mm			
	Gas (Flare)	mm			
	Drain	mm			
Max. interunit piping length	m	20		30	
Max. installation level difference	m	15		20	
Heat insulation		Both liquid and gas piping			

Note: ¹ Rated cooling capacities are based on the following conditions: Indoor temp., 27°CDB, 19.0°CWB; outdoor temp., 35°CDB, Equiv. refrigeration piping: 7.5 m (horizontal).
² Rated heating capacities are based on the following conditions: Indoor temp., 20°CDB, outdoor temp., 7°CDB, 6°CWB, Equiv. refrigeration piping: 7.5 m (horizontal).
³ Anaechoic chamber conversion value, measured according to JIS parameters and criteria. During operation these values are somewhat higher owing to ambient conditions.
⁴ Numerical values are according to ISO 3741:1999.

ROUND FLOW CEILING MOUNTED CASSETTE TYPE (Heat Pump)



Model Name		71	100	125	140	100	125	140
Indoor unit		FCQ71LUV1	FCQ100LUV1	FCQ125LUV1	FCQ140LUV1	FCQ100LUV1	FCQ125LUV1	FCQ140LUV1
Outdoor unit		RZQ71KCV4A	RZQ100KCV4A	RZQ125KCV4A	RZQ140KCV4A	RZQ100HAY4A	RZQ125HAY4A	RZQ140HAY4A
Power supply		1 Phase, 240 V, 50 Hz			3 Phase, 415 V, 50 Hz			
Cooling capacity ¹ Rated (Min. - Max.)	kW	7.1 (3.2-8.0)	10.0 (5.0-11.2)	12.5 (5.7-14.0)	13.6 (6.2-15.4)	10.0 (5.0-11.2)	12.5 (5.7-14.0)	13.6 (6.2-15.4)
Heating capacity ² Rated (Min. - Max.)	kW	8.0 (3.5-9.0)	11.2 (5.1-12.8)	14.0 (6.0-16.2)	16.0 (6.2-18.0)	11.2 (5.1-12.8)	14.0 (6.0-16.2)	16.0 (6.2-18.0)
Power consumption	kW	1.99	2.94	4.02	4.54	2.94	3.77	4.39
Indoor unit		Fresh white						
Fan	Unit	m ³ /min						
	Decomposition panel	mm						
Sound level (H/L) ³	Unit	dB(A)						
	Decomposition panel	mm						
Dimensions (HxWxD)	Unit	mm						
	Decomposition panel	mm						
Machine weight	Unit	kg						
	Decomposition panel	kg						
Certified operation range	CWB	14 to 25						
Outdoor unit		Ivory white						
Compressor	Type	Hermetically sealed swing type			Hermetically sealed scroll type			
	Motor output	kW						
Refrigerant charge (R-410A)	kg	2.75 (Charged for 30 m)	3.7 (Charged for 30 m)	4.3 (Charged for 30 m)	4.3 (Charged for 30 m)	2.2 (Charged for 30 m)	2.9 (Charged for 30 m)	2.9 (Charged for 30 m)
Sound level	Cooling/Heating ³	dB(A)						
	Night quiet mode	dB(A)						
Dimensions (HxWxD)	mm	770x900x320			1,170x900x320			
Machine weight	kg	68			98			
Certified operation range	CWB	-5 to 46						
Piping connections	Liquid (Flare)	mm						
	Gas (Flare)	mm						
	Drain	mm						
Max. interunit piping length	m	50 (Equivalent length 70)			75 (Equivalent length 90)			
Max. installation level difference	m	30						
Heat insulation		Both liquid and gas piping						

Note: ¹ Rated cooling capacities are based on the following conditions: Indoor temp., 27°CDB, 19.0°CWB; outdoor temp., 35°CDB, Equiv. refrigeration piping: 7.5 m (horizontal).
² Rated heating capacities are based on the following conditions: Indoor temp., 20°CDB, outdoor temp., 7°CDB, 6°CWB, Equiv. refrigeration piping: 7.5 m (horizontal).
³ Anaechoic chamber conversion value, measured according to JIS parameters and criteria. During operation these values are somewhat higher owing to ambient conditions.

SPECIFICATIONS

CEILING SUSPENDED TYPE (Cooling Only)



Model Name	Indoor unit	35		50		60		71		100		100		125		
		FHQ35BVV1B	FHQ50BVV1B	FHQ60BVV1B	FHQ71BVV1B	FHQ100BVV1B	FHQ125BVV1B	FHQ100BVV1B	FHQ125BVV1B	FHQ100BVV1B	FHQ125BVV1B	FHQ100BVV1B	FHQ125BVV1B	FHQ100BVV1B	FHQ125BVV1B	
Outdoor unit		RKS35BVMA	RKS50FVMA	RKS60FVMA	RZR71LUV1	RZR100LUV1	RZR125LUV1	RZR100LUV1	RZR125LUV1	RZR100LUV1	RZR125LUV1	RZR100LUV1	RZR125LUV1	RZR100LUV1	RZR125LUV1	
Power supply		1 Phase, 220-240 V, 50 Hz						3 Phase, 380-415 V, 50 Hz								
Cooling capacity ¹ Rated (Min. - Max.)		kW		3.4 (1.2-3.7)	5.0 (1.7-5.6)	5.7 (1.7-6.0)	7.1 (3.2-8.0)	10.0 (5.0-11.2)	12.5 (5.7-14.0)	10.0 (5.0-11.2)	12.5 (5.7-14.0)	10.0 (5.0-11.2)	12.5 (5.7-14.0)	10.0 (5.0-11.2)	12.5 (5.7-14.0)	
Power consumption		kW		1.05	1.72	2.00	2.5	3.51	4.55	3.51	4.55	3.51	4.55	3.51	4.55	
Indoor unit	Colour	White														
	Airflow rate (H)	m ³ /min		13/10	17/13	17/14	24/20	30/25	24/20	30/25	24/20	30/25	24/20	30/25	24/20	30/25
	Sound level (H/L) ²	cfm		458/353	600/458	600/494	847/706	1,059/883	847/706	1,059/883	847/706	1,059/883	847/706	1,059/883	847/706	1,059/883
	Sound level (H/L) ²	dB(A)		37/32	38/33	39/33	42/37	44/39	42/37	44/39	42/37	44/39	42/37	44/39	42/37	44/39
	Dimensions (HxWxD)	mm		195x960x680	195x960x680	195x1,160x680	195x1,400x680	195x1,400x680	195x1,400x680	195x1,400x680	195x1,400x680	195x1,400x680	195x1,400x680	195x1,400x680	195x1,400x680	195x1,400x680
	Machine weight	kg		24	25	27	32	35	32	35	32	35	32	35	32	35
Certified operation range		°CWB		14 to 28		14 to 25		14 to 25		14 to 25		14 to 25		14 to 25		
Outdoor unit	Colour	Ivory white														
	Compressor	Hermetically sealed swing type														
	Motor output	kW		0.6	1.1	1.76	2.03	2.6	2.1	2.6	2.1	2.6	2.1	2.6	2.1	2.6
	Refrigerant charge (R-410A)	kg		1.0 (Charged for 10 m)	1.5 (Charged for 10 m)	1.6 (Charged for 30 m)	3.35 (Charged for 30 m)	3.7 (Charged for 30 m)	2.7 (Charged for 30 m)	3.7 (Charged for 30 m)	2.7 (Charged for 30 m)	3.7 (Charged for 30 m)	2.7 (Charged for 30 m)	3.7 (Charged for 30 m)	2.7 (Charged for 30 m)	3.7 (Charged for 30 m)
	Sound level ²	dB(A)		47	49	48	49	50	49	50	49	50	49	50	49	50
	Night quiet mode	dB(A)		—	—	44	45	45	45	45	45	45	45	45	45	45
Dimensions (HxWxD)	mm		550x765x285	735x825x300	595x845x300	990x940x320	990x940x320	1,170x900x320	990x940x320	1,170x900x320	990x940x320	1,170x900x320	990x940x320	1,170x900x320	990x940x320	
Machine weight	kg		34	47	43	78	97	92	97	92	97	92	97	92	97	
Certified operation range		°CWB		10 to 46		21 to 46		21 to 46		21 to 46		21 to 46		21 to 46		
Piping connections	Liquid (Flare)	mm		Ø9.5	Ø6.4	Ø12.7	Ø9.5	Ø15.9	Ø9.5	Ø15.9	Ø9.5	Ø15.9	Ø9.5	Ø15.9	Ø9.5	
	Gas (Flare)	mm		Ø9.5	Ø6.4	Ø12.7	Ø9.5	Ø15.9	Ø9.5	Ø15.9	Ø9.5	Ø15.9	Ø9.5	Ø15.9	Ø9.5	
	Drain	mm		Ø9.5	Ø6.4	Ø12.7	Ø9.5	Ø15.9	Ø9.5	Ø15.9	Ø9.5	Ø15.9	Ø9.5	Ø15.9	Ø9.5	
Max. interunit piping length	m		20	30	50 (Equivalent length 70)	50 (Equivalent length 70)	50 (Equivalent length 70)	50 (Equivalent length 70)	50 (Equivalent length 70)	50 (Equivalent length 70)	50 (Equivalent length 70)	50 (Equivalent length 70)	50 (Equivalent length 70)	50 (Equivalent length 70)	50 (Equivalent length 70)	
Max. installation level difference	m		15	20	30	30	30	30	30	30	30	30	30	30	30	
Heat insulation		Both liquid and gas piping														

Note: ¹Rated cooling capacities are based on the following conditions: Indoor temp., 27°CDB, 19.0°CWB; outdoor temp., 35°CDB, Equiv. refrigeration piping: 7.5 m (horizontal).
²Anaechoic chamber conversion value, measured according to JIS parameters and criteria. During operation these values are somewhat higher owing to ambient conditions.
³Numerical values are according to ISO 3741:1999.

SPECIFICATIONS

FLOOR STANDING TYPE (Cooling Only)



Model Name	Indoor unit	71		100		125		140		100		125		140	
		FVQ71CVEB	FVQ100CVEB	FVQ125CVEB	FVQ140CVEB	FVQ100CVEB	FVQ125CVEB	FVQ140CVEB	FVQ100CVEB	FVQ125CVEB	FVQ140CVEB	FVQ100CVEB	FVQ125CVEB	FVQ140CVEB	FVQ140CVEB
Outdoor unit		RZR71LUV1	RZR100LUV1	RZR125LUV1	RZR140LUV1	RZR100LUV1	RZR125LUV1	RZR140LUV1	RZR100LUV1	RZR125LUV1	RZR140LUV1	RZR100LUV1	RZR125LUV1	RZR140LUV1	RZR140LUV1
Power supply		1 Phase, 220-240 V, 50 Hz						3 Phase, 380-415 V, 50 Hz							
Cooling capacity ¹ Rated (Min. - Max.)		kW		7.1 (3.2-8.0)	10.0 (5.0-11.2)	12.5 (5.7-14.0)	13.5 (6.2-15.4)	10.0 (5.0-11.2)	12.5 (5.7-14.0)	13.5 (6.2-15.4)	10.0 (5.0-11.2)	12.5 (5.7-14.0)	13.5 (6.2-15.4)	10.0 (5.0-11.2)	13.5 (6.2-15.4)
Power consumption		kW		2.58	3.28	4.39	5.40	3.28	4.39	5.40	3.28	4.39	5.40	3.28	5.40
Indoor unit	Colour	Fresh white													
	Fan	Airflow rate (H/M/L)		m ³ /min		18/16/14	28/25/22	28/26/24	30/28/26	28/25/22	28/26/24	30/28/26	28/25/22	28/26/24	30/28/26
	Sound level ²	cfm		cfm		635/565/494	988/883/777	988/918/847	1,059/988/918	988/883/777	988/918/847	1,059/988/918	988/883/777	988/918/847	1,059/988/918
	Sound level ²	dB(A)		dB(A)		43/41/38	50/47/44	51/48/46	53/51/48	43/41/38	50/47/44	51/48/46	53/51/48	43/41/38	50/47/44
	Dimensions (HxWxD)	mm		mm		1,850x600x270	1,850x600x270	1,850x600x270	1,850x600x350	1,850x600x270	1,850x600x270	1,850x600x270	1,850x600x350	1,850x600x270	1,850x600x270
	Machine weight	kg		kg		39	47	47	47	39	47	47	47	39	47
Certified Operation range		°CWB		°CWB		14 to 25		14 to 25		14 to 25		14 to 25		14 to 25	
Outdoor unit	Colour	Ivory white													
	Compressor	Hermetically sealed swing type													
	Motor output	kW		1.76	2.3	2.8	3.4	2.3	2.8	3.4	2.3	2.8	3.4	2.3	3.4
	Refrigerant charge (R-410A)	kg		1.6 (Charged for 30 m)	3.35 (Charged for 30 m)	3.7 (Charged for 30 m)	4.3 (Charged for 30 m)	2.7 (Charged for 30 m)	3.7 (Charged for 30 m)	4.3 (Charged for 30 m)	2.7 (Charged for 30 m)	3.7 (Charged for 30 m)	4.3 (Charged for 30 m)	2.7 (Charged for 30 m)	3.7 (Charged for 30 m)
	Sound level ²	dB(A)		48	49	49	50	49	50	48	49	49	50	48	49
	Night quiet mode	dB(A)		44	45	45	46	45	46	44	45	45	46	44	45
Dimensions (HxWxD)	mm		mm		595x845x300	990x940x320	990x940x320	1,170x900x320	595x845x300	990x940x320	990x940x320	1,170x900x320	595x845x300	990x940x320	
Machine weight	kg		kg		43	78	97	92	43	78	97	92	43	78	
Certified Operation range		°CWB		°CWB		21 to 46		21 to 46		21 to 46		21 to 46		21 to 46	
Piping connections	Liquid (Flare)	mm		Ø9.5	Ø6.4	Ø12.7	Ø9.5	Ø15.9	Ø9.5	Ø15.9	Ø9.5	Ø15.9	Ø9.5	Ø15.9	Ø9.5
	Gas (Flare)	mm		Ø9.5	Ø6.4	Ø12.7	Ø9.5	Ø15.9	Ø9.5	Ø15.9	Ø9.5	Ø15.9	Ø9.5	Ø15.9	Ø9.5
	Drain	mm		Ø9.5	Ø6.4	Ø12.7	Ø9.5	Ø15.9	Ø9.5	Ø15.9	Ø9.5	Ø15.9	Ø9.5	Ø15.9	Ø9.5
Max. interunit piping length	m		20	30	50 (Equivalent length 70)	50 (Equivalent length 70)	50 (Equivalent length 70)	50 (Equivalent length 70)	20	30	50 (Equivalent length 70)	50 (Equivalent length 70)	20	30	
Max. installation level difference	m		15	20	30	30	30	30	15	20	30	30	15	20	
Heat insulation		Both liquid and gas piping													

Note: ¹Rated cooling capacities are based on the following conditions: Suction temp., 27°CDB, 19.0°CWB; outdoor temp., 35°CDB, 24°CDB, Equiv. refrigeration piping: 7.5 m (horizontal).
²Anaechoic chamber conversion value, measured according to JIS parameters and criteria. During operation these values are somewhat higher owing to ambient conditions.

CEILING SUSPENDED TYPE (Heat Pump)



Model Name	Indoor unit	35		50		60		71		100		100		125		
		FHQ35BVV1B	FHQ50BVV1B	FHQ60BVV1B	FHQ71BVV1B	FHQ100BVV1B	FHQ125BVV1B	FHQ100BVV1B	FHQ125BVV1B	FHQ100BVV1B	FHQ125BVV1B	FHQ100BVV1B	FHQ125BVV1B	FHQ100BVV1B	FHQ125BVV1B	
Outdoor unit		RXS35BVMA	RXS50FVMA	RXS60FVMA	RZQ71KCV4A	RZQ100KCV4A	RZQ125KCV4A	RZQ100HAY4A	RZQ125HAY4A	RZQ100HAY4A	RZQ125HAY4A	RZQ100HAY4A	RZQ125HAY4A	RZQ100HAY4A	RZQ125HAY4A	
Power supply		1 Phase, 220-240 V, 50 Hz						3 Phase, 380-415 V, 50 Hz								
Cooling capacity ¹ Rated (Min. - Max.)		kW		3.4 (1.2-3.7)	5.0 (1.7-5.6)	5.7 (1.7-6.0)	7.1 (3.2-8.0)	10.0 (5.0-11.2)	11.2 (5.7-14.0)	9.2 (5.0-11.2)	11.2 (5.7-14.0)	9.2 (5.0-11.2)	11.2 (5.7-14.0)	10.0 (5.0-11.2)	12.5 (5.7-14.0)	
Heating capacity ² Rated (Min. - Max.)		kW		4.0 (1.2-5.0)	6.0 (1.7-7.0)	7.2 (1.7-8.0)	7.5 (3.5-9.0)	10.5 (5.1-12.8)	13.5 (6.0-16.2)	10.5 (5.1-12.8)	13.5 (6.0-16.2)	10.5 (5.1-12.8)	13.5 (6.0-16.2)	11.2 (5.1-12.8)	16.0 (6.2-18.0)	
Power consumption		kW		1.05	1.72	2.00	2.32	3.26	3.77	2.85	3.26	2.85	3.26	3.55	4.35	
Indoor unit	Colour	White														
	Airflow rate (H/L)	m ³ /min		13/10	17/13	17/14	24/20	30/25	24/20	30/25	24/20	30/25	24/20	30/25	24/20	30/25
	Sound level (H/L) ²	cfm		458/353	600/458	600/494	847/706	1,059/883	847/706	1,059/883	847/706	1,059/883	847/706	1,059/883	847/706	1,059/883
	Sound level (H/L) ²	dB(A)		37/32	38/33	39/33	42/37	44/39	42/37	44/39	42/37	44/39	42/37	44/39	42/37	44/39
	Dimensions (HxWxD)	mm		195x960x680	195x960x680	195x1,160x680	195x1,400x680	195x1,400x680	195x1,400x680	195x1,400x680	195x1,400x680	195x1,400x680	195x1,400x680	195x1,400x680	195x1,400x680	195x1,400x680
	Machine weight	kg		24	25	27	32	35	32	35	32	35	32	35	32	35
Certified operation range		°CWB		14 to 28		14 to 25		14 to 25		14 to 25		14 to 25		14 to 25		
Outdoor unit	Colour	Ivory white														
	Compressor	Hermetically sealed swing type														
	Motor output	kW		1.6	1.1	1.7	1.9	2.4	2.3	2.7	2.4	2.7	2.4	2.7	2.4	2.7
	Refrigerant charge (R-410A)	kg		1.0 (Charged for 10 m)	1.5 (Charged for 10 m)	1.6 (Charged for 30 m)	3.7 (Charged for 30 m)	3.7 (Charged for 30 m)	4.3 (Charged for 30 m)	3.7 (Charged for 30 m)	4.3 (Charged for 30 m)	3.7 (Charged for 30 m)	4.3 (Charged for 30 m)	3.7 (Charged for 30 m)	4.3 (Charged for 30 m)	
	Sound level ²	dB(A)		47/48	49/49	48/50	49/51	50/52	49/51	50/52	49/51	50/52	49/51	50/52	49/51	50/52
	Night quiet mode	dB(A)		44	45	44	45	45	45	45	45	45	45	45	45	45
Dimensions (HxWxD)	mm		550x765x285	735x825x300	770x900x320	1,170x900x320	1,170x									

SPECIFICATIONS

CEILING MOUNTED SLIM DUCT TYPE (Heat Pump)



Model Name		25	35	50	60
Indoor unit		FDXS25CVMA	FDXS35CVMA	FDXS50CVMA	FDXS60CVMA
Outdoor unit		RXS25EBVMA	RXS35EBVMA	RXS50FVMA	RXS60FVMA
Power supply		1 Phase, 220-240 V, 50 Hz			
Cooling capacity ¹ Rated (Min. - Max.)	kW	2.4 (1.2-3.0)	3.4 (1.2-3.8)	5.0 (1.7-5.3)	6.0 (1.7-6.5)
Heating capacity ² Rated (Min. - Max.)	kW	3.2 (1.2-4.5)	4.0 (1.2-5.0)	5.8 (1.7-6.0)	7.0 (1.7-8.0)
Power consumption	Cooling ¹	0.69 (0.3-0.92)	1.09 (0.3-1.27)	1.65 (0.44-1.93)	2.13 (0.44-2.49)
	Heating ²	0.91 (0.29-1.49)	1.18 (0.29-1.79)	1.92 (0.4-2.04)	2.32 (0.4-3.18)
Indoor unit	Airflow rate (H/L)	158/133	167/142	200/167	266/225
	Fan External static pressure Driving system	9.5/8	10/8.5	12/10	16/13.5
Outdoor unit	Compressor Type	Hermetically sealed swing type			
	Motor output	0.6		1.1	
	Refrigerant charge (R-410A)	1.0 (Charged for 10 m)			
	Sound level ³	46/47	47/48	61/62	63/63
	Sound power	61/62	62/63	61/62	63/63
	Dimensions (HxWxD)	550x765x285		735x825x300	
	Machine weight	34		48	
	Certified	Cooling	14 to 28		
	Operation range	Heating	10 to 30		
	Colour	Ivory white			
Piping connections	Liquid (Flare)	Ø9.5			
	Gas (Flare)	Ø12.7			
Max. interunit piping length	m	20		30	
Max. installation level difference	m	15		20	
Heat insulation	Both liquid and gas piping				

Note: ¹Rated cooling capacities are based on the following conditions: Suction temp., 27°CDB, 19.0°CWB; outdoor temp., 35°CDB, Equiv. refrigeration piping: 7.5 m (horizontal).
²Rated heating capacities are based on the following conditions: Suction temp., 20°CDB; outdoor temp., 7°CDB, 6°CWB, Equiv. refrigeration piping: 5 m (horizontal).
³Anaechoic chamber conversion value, measured according to JIS parameters and criteria. During operation these values are somewhat higher owing to ambient conditions.
⁴Numerical values are according to ISO 3741:1999

SPECIFICATIONS

DUCT CONNECTION MIDDLE AND HIGH STATIC PRESSURE TYPE (Heat Pump)



Model Name		71	100	125	140	100	125	140	
Indoor unit		FBQ71DV1	FBQ100DV1	FBQ125DV1	FBQ140DV1	FBQ100DV1	FBQ125DV1	FBQ140DV1	
Outdoor unit		RZQ71KCV4A	RZQ100KCV4A	RZQ125KCV4A	RZQ140KCV4A	RZQ100HAY4A	RZQ125HAY4A	RZQ140HAY4A	
Power supply		Indoor unit : 1 Phase, 220-240 V, 50 Hz Outdoor unit : 1 Phase, 240 V, 50 Hz				Indoor unit : 1 Phase, 220-240 V, 50 Hz Outdoor unit : 3 Phase, 415 V, 50 Hz			
Cooling capacity ¹ Rated (Min. - Max.)	kW	7.1 (3.2-8.0)	10.0 (5.0-11.2)	12.5 (5.7-14.0)	13.1 (6.2-15.4)	10.0 (5.0-11.2)	12.5 (5.7-14.0)	13.1 (6.2-15.4)	
Heating capacity ² Rated (Min. - Max.)	kW	8.0 (3.5-9.0)	11.2 (5.1-12.8)	14.0 (6.0-16.2)	16.0 (6.2-18.0)	11.2 (5.1-12.8)	14.0 (6.0-16.2)	16.0 (6.2-18.0)	
Power consumption	Cooling ¹	2.22	3.17	3.97	4.16	3.17	3.97	4.16	
	Heating ²	2.43	3.15	3.95	4.68	3.15	3.95	4.68	
Indoor unit	Colour	-----							
	Fan Airflow rate (H/L)	32/23		39/28		32/23		39/28	
	External static pressure ³ (Middle-High)	50-200							
	Sound level ⁴	35/28	43/32	44/34	44/36	43/32	44/34	44/36	
	Dimensions (HxWxD)	300x1,000x700		300x1,400x700		300x1,400x700		300x1,400x700	
	Machine weight	36		46		46		46	
	Certified	Cooling	14 to 25						
	Operation range	Heating	15 to 27						
	Colour	Ivory white							
	Outdoor unit	Compressor Type	Hermetically sealed swing type		Hermetically sealed scroll type				
Motor output		1.7	1.9	2.4	2.9	1.9	2.4	2.9	
Refrigerant charge (R-410A)	kg	2.75 (Charged for 30 m)	3.7 (Charged for 30 m)		4.3 (Charged for 30 m)				
Sound level ⁵	Cooling/Heating ²	48/50	49/51	50/52		49/51	50/52		
	Night quiet mode	44	45	46		45	46		
Dimensions (HxWxD)	mm	770x900x320		1,170x900x320		1,345x900x320			
Machine weight	kg	68		98		108			
Certified	Cooling	-5 to 46							
Operation range	Heating	-15 to 15.5							
Piping connections	Liquid (Flare)	Ø9.5							
	Gas (Flare)	Ø15.9							
Drain	Indoor unit	1.DØ25xO.DØ32							
	Outdoor unit	Ø26.0 (Hole)							
Max. interunit piping length	m	50 (Equivalent length 70)	75 (Equivalent length 90)		75 (Equivalent length 90)				
Max. installation level difference	m	30							
Heat insulation	Both liquid and gas piping								

Note: ¹Rated cooling capacities are based on the following conditions: Indoor temp., 27°CDB, 19.0°CWB; outdoor temp., 35°CDB, 24°CWB, Equiv. refrigeration piping: 7.5 m (horizontal).
²Rated heating capacities are based on the following conditions: Indoor temp., 20°CDB; outdoor temp., 7°CDB, 6°CWB, Equiv. refrigeration piping: 7.5 m (horizontal).
³Initial setting is standard.
⁴Anaechoic chamber conversion value, measured according to JIS parameters and criteria. During operation these values are somewhat higher owing to ambient conditions.

DUCT CONNECTION MIDDLE AND HIGH STATIC PRESSURE TYPE (Cooling Only)



Model Name		50	60	71	100	125	140	100	125	140	
Indoor unit		FBQ50DV1	FBQ60DV1	FBQ71DV1	FBQ100DV1	FBQ125DV1	FBQ140DV1	FBQ100DV1	FBQ125DV1	FBQ140DV1	
Outdoor unit		RZR50LUV1	RZR60LUV1	RZR71LUV1	RZR100LUV1	RZR125LUV1	RZR140LUV1	RZR100LUV1	RZR125LUV1	RZR140LUV1	
Power supply		1 Phase, 220-240 V, 50 Hz									
Cooling capacity ¹ Rated (Min. - Max.)	kW	5.0 (2.3-5.6)	6.0 (2.6-6.3)	7.1 (3.2-8.0)	10.0 (5.0-11.2)	12.5 (5.7-14.0)	14.0 (6.2-15.4)	10.0 (5.0-11.2)	12.5 (5.7-14.0)	14.0 (6.2-15.4)	
Power consumption	kW	1.39	1.69	2.22	2.82	3.73	4.71	2.82	3.73	4.71	
Indoor unit	Colour	-----									
	Fan Airflow rate (H/L)	18/15		32/23		39/28		32/23		39/28	
External static pressure ³ (Middle-High)	Pa	50-200									
Sound level ⁴	Cooling (H/L)	37/32		38/33		40/36		38/33		40/36	
Dimensions (HxWxD)	mm	300x1,000x700				300x1,400x700					
Machine weight	kg	36		46		46					
Certified	Operation range	14 to 25									
Outdoor unit	Colour	Ivory white									
	Compressor Type	Hermetically sealed swing type			Hermetically sealed scroll type						
Motor output	kW	1.12	1.35	1.76	2.03	2.4	2.9	1.8	2.4	2.9	
Refrigerant charge (R-410A)	kg	1.6 (Charged for 30 m)		3.35 (Charged for 30 m)		3.7 (Charged for 30 m)		2.7 (Charged for 30 m)		3.7 (Charged for 30 m)	
Sound level ⁵	Cooling	48		49		50		49		50	
	Night quiet mode	44		45		46		45		46	
Dimensions (HxWxD)	mm	595x845x300		990x940x320		1,170x900x320					
Machine weight	kg	43		78		97		92		97	
Certified	Operation range	21 to 46									
Piping connections	Liquid (Flare)	Ø9.5									
	Gas (Flare)	Ø15.9									
Drain	Indoor unit	1.DØ25xO.DØ32									
	Outdoor unit	Ø26.0 (Hole)									
Max. interunit piping length	m	50 (Equivalent length 70)									
Max. installation level difference	m	30									
Heat insulation	Both liquid and gas piping										

Note: ¹Rated cooling capacities are based on the following conditions: Suction temp., 27°CDB, 19.0°CWB; outdoor temp., 35°CDB, 24°CWB, Equiv. refrigeration piping: 7.5 m (horizontal).
²Initial setting is standard.
³Anaechoic chamber conversion value, measured according to JIS parameters and criteria. During operation these values are somewhat higher owing to ambient conditions.

OPTIONS

ROUND FLOW CEILING MOUNTED CASSETTE TYPE

R-410A

Name of option	Remark	Kit name					
		FCNQ18MV1	FCNQ21MV1	FCNQ26MV1	FCNQ30MV1	FCNQ36MV1	FCNQ42MV1
Decoration panel		BYCP125K-W1					
Sealing material of air discharge outlet		KDBH55K160F					
Panel spacer		KDBP55H160FA					
Fresh air intake kit ¹	Chamber type	Without the T-joint pipe and fan					
		With the T-joint pipe, without fan					
Direct installation type		KDDP55B160					
Chamber connection kit ²		KDDP55B160K					
Insulation kit for high humidity		KDDP55X160					
High-efficiency filter	(Colorimetric method 65%)	KK5J55KA160					
	(Colorimetric method 90%)	KD1P55K80					
Replacement high-efficiency filter	(Colorimetric method 65%)	KAFP556880					
	(Colorimetric method 90%)	KAFP557880					
Filter chamber	(Colorimetric method 65%)	KAFP552880					
	(Colorimetric method 90%)	KAFP553880					
Replacement long-life filter		KDDFP55B160					
Ultra long-life filter		KAFP551K160					
Replacement ultra long-life filter		KAFP558160					
Branch duct chamber		KAFP55H160H					
Remote controller	Wireless type	Cooling Only					
	Wired type ⁴	BRC7F633F					
Wired LCD remote controller with weekly schedule timer ⁴		BRC1C61					
Navigation Remote Controller	Wired type ⁴	BRC1D61					
Central remote controller ²		DCS302CA61					
Unified ON/OFF controller ²		DCS301BA61					
Schedule timer ²		DST301BA61					
Intelligent Touch Controller ²		DCS601C51					
Adaptor for wiring ³		KRP1C63					
Wiring adaptor for electrical appendices ³		KRP4AA53					
Installation box for adaptor PCB		KRP1H98					
Remote sensor (for indoor temperature)		KRCS01-4B					

Note: ¹Installation box for adaptor PCB (KRP1H98) is necessary.
²This type of indoor units is equipped with the interface adaptor for SkyAir series.
³Required for installing high-efficiency filter or ultra long-life filter.
⁴Wiring for wired remote controller to be procured locally.

CEILING MOUNTED CASSETTE TYPE

R-22

Name of option	Remark	Kit name						
		Cooling Only						
		FHC18NU	FHC21NU	FHC26NU	FHC30NU	FHC36NU	FHC42NU	FHC48NU
Decoration panel		BYC125K-W1, BYC125K-W2						
Sealing member for air discharge outlet		KDBHJ49F80						
Panel spacer		KDBP55H160WA						
Fresh air intake kit ¹	Chamber type	Without the T-joint pipe and fan						
		With the T-joint pipe, without fan						
Direct installation type		KDDP55D160						
Chamber connection kit ²		KDDJ55X160						
High-efficiency filter	(Colorimetric method 65%)	KAFP556D80			KAFP556D160			
	(Colorimetric method 90%)	KAFP557D80			KAFP557D160			
Replacement high-efficiency filter	(Colorimetric method 65%)	KAFP552D80			KAFP552D160			
	(Colorimetric method 90%)	KAFP553D80			KAFP553D160			
High-efficiency filter chamber		KDDFP55D160						
Replacement long-life filter		KAFJ551K160						
Ultra long-life filter		KAFP55D160						
Replacement ultra long-life filter		KAFJ55K160H						
Branch duct chamber		KDJ55K80			KDJ55K160			
Remote controller	Wired type ²	BRC1C61						
	Wireless type	BRC7C613W						
Wired LCD remote controller with weekly schedule timer		BRC1D61						
Central remote controller ¹		DCS302CA61						
Unified ON/OFF controller ¹		DCS301BA61						
Schedule timer ¹		DST301BA61						
Intelligent touch controller		DCS601C51						
Adaptor for wiring ³		DRP1BA57						
Wiring adaptor for electrical appendices ²		KRP4AA53						
Interface adaptor for SkyAir series		DTA102A52						
Installation box for adaptor PCB		KRP1B98						

Note: ¹This optional accessory requires DTA102A52.
²Installation box for adaptor PCB (KRP1B98) is necessary.
³Required for installing high-efficiency filter or ultra long-life filter.
⁴Refer to page 89 for details.

OPTIONS

CEILING MOUNTED CASSETTE TYPE

R-22

Name of option	Remark	Kit name	
		Heat Pump	
		FHYC50K/60K/71K	FHYC100K/125K/140K
Decoration panel		BYC125KW1	
Sealing member for air discharge outlet		KDBHJ55K160	
Panel spacer		KDBP55H160WA	
Fresh air intake kit ¹	Chamber Type	Without the T-joint pipe and fan	
		With the T-joint pipe and fan	
Direct installation type		KDDP55D160K	
Chamber connection kit ²		KDDJ55X160	
High-efficiency filter	(Colorimetric method 65%)	KAFP556D80	KAFP556D160
	(Colorimetric method 90%)	KAFP557D80	KAFP557D160
Replacement high-efficiency filter	(Colorimetric method 65%)	KAFP552H80	KAFP552H160
	(Colorimetric method 90%)	DAFP553H80	KAFP553H160
High-efficiency filter chamber		KDDFP55D160	
Replacement long-life filter		KAFJ551K160	
Ultra long-life filter		KAFP55D160	
Replacement ultra long-life filter		KAFJ55K160H	
Branch duct chamber		KDJ55K80	KDJ55K160
Remote controller	Wired type ³	BRC1C61	
	Wireless type	BRC7C612W	
Wired LCD remote controller with weekly schedule timer		BRC1D61	
Central remote controller ⁴		DCS302CA61	
Unified ON/OFF controller ⁴		DCS301BA61	
Schedule timer ⁴		DST301BA61	
Intelligent Touch Controller ⁴		DCS601C51	
Adaptor for wiring ³		KRP1BA57	
Wiring adaptor for electrical appendices ⁵		KRP4AA53	
Interface adaptor for SkyAir series		DTA102A52	
Installation box for adaptor PCB		KRP1B98	

Note: ¹Refer to page 89 for the details.
²Required for installing high-efficiency or ultra long-life filter.
³Wiring for wired remote controller to be procured locally.
⁴This optional accessory requires DTA102A52.
⁵Installation box for adaptor PCB (KRP1B98) is necessary.

NEW CEILING SUSPENDED CASSETTE TYPE

R-22

Name of option	Remark	Kit name	
		Cooling Only	
		FUY71	FUY100/125
Replacement long-life filter		KAFJ495F140	
Sealing member for air discharge outlet ¹		KDBHJ49F80	KDBHJ49F140
Decoration panel for air discharge		KDBTJ49F80	KDBTJ49F140
Vertical flap kit		KDGJ49F80	KDGJ49F140
L-connection piping kit		KHFJ49F80	KHFJ49F140
Remote controller	Wired type ²	BRC1C61	
	Wireless type	BRC7C529W	
Set back time clock		BRC15A61	
Central remote controller ³		DCS302B61	
Unified ON/OFF controller ³		DCS301B61	
Schedule timer ³		DST301B61	
Intelligent Touch Controller ⁴		DCS601C51	
Wiring adaptor for electrical appendices ⁴		KRP4A53	
Interface adaptor for SkyAir series		DTA102A52	
Installation box for adaptor PCB		KRP1B97	

Note: ¹Required at time of installation for setting two-way opposing air flow.
²Wiring for wired remote controller to be procured locally.
³This optional accessory requires DTA102A52.
⁴Installation box for adaptor PCB (KRP1B97) is necessary.

CEILING SUSPENDED TYPE

R-22

Name of option	Remark	Kit name										
		Cooling Only					Heat Pump					
		FH21NU	FH26NU	FH30NU	FH36NU	FH42NU	FH48NU	FHY50B	FHY60B	FHY71B	FHY100B	FHY125B
Replacement long-life filter	Resin net	KAFJ501D80	KAFJ501D112	KAFJ501D160			KAFJ501D80					
Drain-up kit							KDU50B50VE	KDU50B71VE	KDU50B125VE			
L-type piping kit (for forward direction)		KHFJ5F80			KHFJ5F160			KHFJ5F60	KHFJ5F80	KHFJ5F160		
Remote controller	Wired type ¹	BRC1NU61					BRC1C61					
	Wireless type	BRC7NU66					BRC7E63W					
Wired LCD remote controller with weekly schedule timer		BRC1D61										
Central remote controller ²		DCS302CA61										
Unified ON/OFF controller ²		DCS301BA61										
Schedule timer ²		DST301BA61										
Intelligent Touch Controller ²		DCS601C51										
Adaptor for wiring		KRP1BA54										
Wiring adaptor for electrical appendices ³		KRP4AA52										
Interface adaptor for SkyAir series		DTA102A52										
Installation box for adaptor PCB		KRP1CA93										

Note: ¹Wiring for wired remote controller to be procured locally.
²This optional accessory requires DTA102A52.
³Installation box for adaptor PCB (KRP1CA93) is necessary.

WALL MOUNTED TYPE

R-22

Name of option	Remark	Kit name	
		Cooling Only	
		FAY71	FAY100
Drain-up kit		K-KDU572BVE	
Remote Controller	Wired type ¹	BRC1C61	
	Wireless type	BRC7E619	BRC7C611W
Set back time clock		BRC15A61	
Central remote controller		DCS302B61	DCS302B61 ²
Unified ON/OFF controller		DCS301B61	DCS301B61 ²
Schedule timer		DST301B61	DST301B61 ²
Intelligent Touch Controller		DCS601B51	DCS601B51 ²
Wiring adaptor for electrical appendices		KRP4A51 ³	KRP4A51
Interface adaptor for SkyAir Series		-----	DTA102A52
Installation box for adaptor PCB		KRP4A93	-----

Note: ¹Wiring for wired remote controller to be procured locally.
²This optional accessory requires DTA102A52.
³Installation box for adaptor PCB (KRP4A93) is necessary.

OPTIONS

FLOOR STANDING TYPE

R-22

Name of option	Remark	Kit name	
		Cooling Only	Heat Pump
		FV71/100/125	
Replacement long-life filter		KAFJ95L160	
Set back time clock		BRC15A61	
Central remote controller ¹		DCS302B61	
Unified ON/OFF controller ¹		DCS301B61	
Schedule timer ¹		DST301B61	
Intelligent Touch Controller ²		DCS601C51	
Remote controller for 2 remote control system		BRC1C61	
Adaptor for wiring ²		KRP1B57	
Group control adaptor ²		KRP4A52	
Interface adaptor for SkyAir series		DTA102A52	
Installation box for adaptor PCB		KRP4A95	

Note: ¹This optional accessory requires DTA102A52.
²Installation box for adaptor PCB (KRP4A95) is necessary.

DUCT CONNECTION TYPE

R-22

Name of option	Remark	Low static pressure type			
		Cooling Only		Heat Pump	
		FDB25/35/50	FDB60/71	FDYB35KA/50KA	FDYB60/71KA
Wired LCD remote controller with weekly schedule timer		----	----	BRC1D61	
Remote controller		KRC47-1A	KRC47-1A	----	
Wired LCD remote controller		----	----	BRC1C61	
Digital remote controller		KRC47-2A	KRC47-2A	----	
Digital remote controller for duct heater use		KRC47-4A	KRC47-4A	----	
Wireless remote controller		----	----	BRC4C62	
Central remote controller		----	----	DCS302CA61 ¹	
Unified ON/OFF controller		----	----	DCS301BA61 ¹	
Schedule timer		----	----	DST301BA61 ¹	
Intelligent Touch Controller		----	----	DCS601C51 ¹	
Remote sensor (for indoor temperature)		----	----	----	
Central control adaptor kit		----	----	----	
Adaptor for wiring		----	----	KRP1BA54	
Wiring adaptor for electrical appendices		----	----	KRP4AA52 ²	
Switch box for adaptor kit		----	----	KRP1B100	
Interface adaptor for SkyAir series ³		----	----	DTA102A52	
Installation box for adaptor PCB		----	----	----	
Suction grille		KDGF19A45	KDGF19A71	KDGF19A45	KDGF19A71
Drain pan cover		KKD19A1	KKD19A1	KKD19A1	KKD19A1

Note: ¹This optional accessory requires DTA102A52.
²This optional accessory requires KRP1B100.
³Installation plate for adaptor PCB (KRP4A95) is necessary.

DUCT CONNECTION MIDDLE STATIC PRESSURE TYPE

R-22

Name of option	Kit name	
	Cooling Only	Heat Pump
	FDMG26/30/36/42/48/56NU	FDYM03/04/05/06FA
Remote controller	KRC47-1A	---
Wired LCD remote controller	---	BRC1D61
With weekly schedule timer	---	BRC1C61
Digital remote controller	KRC47-2A	---
Digital remote for duct heater use	KRC47-4A	---
Wireless remote controller	---	BRC4C62
Central remote controller	---	DCS302CA61 ¹
Unified ON/OFF controller	---	DCS301BA61 ¹
Schedule timer	---	DST301BA61 ¹
Intelligent Touch Controller	---	DCS601C51 ¹
Wiring adaptor for electrical appendices	---	KRP4AA51 ²
Interface adaptor for SkyAir series	---	DTA102A52

Note: ¹This optional accessory requires DTA102A52.
²Installation plate for adaptor PCB (KRP4A95) is necessary.

OPTIONS

COMPACT MULTI FLOW CEILING MOUNTED CASSETTE TYPE

INVERTER R-410A

Name of option	Remark	Kit name			
		Cooling Only & Heat Pump			
		FFQ25BV1B	FFQ35BV1B	FFQ50BV1B	FFQ60BV1B
Decoration panel				BYFQ60B8W1	
Remote controller	Wireless type			BRC7E530W	
	Heat Pump Cooling Only			BRC7E531W	
	Wired type ¹ "Nav Ease"			BRC1E62	
Adaptor for wiring ²				KRP1BA57	
Wiring adaptor for electrical appendices ²				KRP4AA53	
Remote sensor (for indoor temperature)				KRC501-1B	
Installation box for adaptor PCB				KRP1BA101	
Central remote controller ³				DCS302CA61	
Unified ON/OFF controller ³				DCS301BA61	
Schedule timer ³				DST301BA61	
Intelligent Touch Controller ³				DCS601C51	
Interface adaptor for SkyAir series				DTA112BA51	
Replacement long-life filter				KAFQ441B60	
Fresh air intake kit	Direct installation type			KDDQ44X60	
Sealing member for air discharge outlet				KDBHQ44B60	
Panel spacer				KDBQ44B60	

Note: ¹Wiring for wired remote controller to be procured locally. ²Installation box for adaptor PCB (KRP1BA101) is necessary. ³This optional accessory requires DTA112BA51.

CEILING MOUNTED CASSETTE TYPE (ROUND FLOW)

INVERTER R-410A

Name of option	Remark	Kit name					
		FCQ50LUV1	FCQ60LUV1	FCQ71LUV1	FCQ100LUV1	FCQ125LUV1	FCQ140LUV1
Decoration panel						BYCP125K-W1	
Sealing material of air discharge outlet						KDBH55K160F	
Panel spacer						KDBP55H160FA	
Fresh air intake kit ¹	Chamber type					KDDP55B160	
	Without the T-joint pipe and fan					KDDP55B160K	
	With the T-joint pipe, without fan					KDDP55X160	
	Direct installation type					KDDP55X160	
Chamber connection kit ²						KKSJ55KA160	
Insulation kit for high humidity			KDTP55K80			KDTP55K160	
High-efficiency filter	(Colorimetric method 65%)		KAFP556B80			KAFP556B160	
	(Colorimetric method 90%)		KAFP557B80			KAFP557B160	
Replacement high-efficiency filter	(Colorimetric method 65%)		KAFP552B80			KAFP552B160	
	(Colorimetric method 90%)		KAFP553B80			KAFP553B160	
Filter chamber						KDDFP55B160	
Replacement long-life filter						KAFP551K160	
Ultra long-life filter						KAFP55B160	
Replacement ultra long-life filter						KAFP55H160H	
Branch duct chamber			KDJP55B80			KDJP55B160	
Remote controller	Wireless type			Cooling Only		BRC7F633F	
	Heat Pump			Heat Pump		BRC7F632F	
	Wired type ³					BRC1C61	
Wired LCD remote controller with weekly schedule timer ³						BRC1D61	
Navigation Remote Controller						BRC1E62	
Central remote controller ⁴						DCS302CA61	
Unified ON/OFF controller ⁴						DCS301BA61	
Schedule timer ⁴						DST301BA61	
Intelligent Touch Controller ⁴						DCS601C51	
Adaptor for wiring ⁵						KRP1C63	
Wiring adaptor for electrical appendices ⁵						KRP4AA53	
Installation box for adaptor PCB						KRP1H98	
Remote sensor (for indoor temperature)						KRC501-4B	

Note: ¹Refer to page 89 for the details. ²Required for installing high-efficiency filter or ultra long-life filter. ³Wiring for wired remote controller to be procured locally. ⁴This type of indoor units is equipped with the interface adapter for SkyAir series. DTA112BA51 is unnecessary. ⁵Installation box for adaptor PCB (KRP1H98) is necessary.

CEILING SUSPENDED TYPE

INVERTER R-410A

Name of option	Remark	Kit name					
		Cooling Only & Heat Pump					
		FHQ35BVV1B	FHQ50BVV1B	FHQ60BVV1B	FHQ71BVV1B	FHQ100BVV1B	FHQ125BVV1B
Replacement long-life filter	Resin net		KAF501DA56		KAF501DA80		KAF501DA160
Drain-up kit			KDU50N60VE				KDU50N125VE
L-type piping kit (for upward direction)		KHFP5MA35		KHFP5MA63			KHFP5MA160
Remote controller	Wireless type					BRC7EA63W	
	Heat Pump Cooling Only					BRC7EA66	
	Wired type ¹ "Nav Ease"					BRC1E62	
Central remote controller ²						DCS302CA61	
Unified ON/OFF controller ²						DCS301BA61	
Schedule timer ²						DST301BA61	
Intelligent Touch Controller ²						DCS601C51	
Adaptor for wiring						KRP1BA54	
Wiring adaptor for electrical appendices ³						KRP4AA52	
Interface adaptor for SkyAir series						DTA112BA51	
Installation box for adaptor PCB						KRP1CA93	
Remote sensor (for indoor temperature)						KRC501-1B	
Electrical box with earth terminal (3 blocks)						KJB311AA	
Electrical box with earth terminal (2 blocks)						KJB212AA	

Note: ¹Wiring for wired remote controller to be procured locally. ²This optional accessory requires DTA112BA51.
³Installation box for adaptor PCB (KRP1CA93) is necessary.

OPTIONS

FLOOR STANDING TYPE



Name of option	Remark	Kit name			
		FVQ71CVEB	FVQ100CVEB	FVQ125CVEB	FVQ140CVEB
Replacement long-life filter				KAFJ95L160	
Navigation Remote Controller	Wired type ¹			BRC1E62	
Central remote controller ²				DCS302CA61	
Unified ON/OFF controller ²				DCS301BA61	
Schedule timer ²				DST301BA61	
Intelligent Touch Controller ²				DCS601CS1	
Adaptor for wiring ³				KRP1BA57	
Wiring adaptor for electrical appendices				KRP4AA52	
Installation box for adaptor PCB				KRP4AA95	

Note:
¹Wiring for wired remote controller to be procured locally.
²This type of indoor units is equipped with the interface adaptor for SkyAir Series, DTA112BA51 is unnecessary.
³Installation box for adaptor PCB (KRP4AA95) is necessary.

CEILING MOUNTED SLIM DUCT TYPE



Name of option	Remark	Kit name			
		Heat Pump			
		FDXS25CVMA	FDXS35CVMA	FDXS50CVMA	FDXS60CVMA
Wired remote controller ¹				BRC94B2	
Wired remote controller code	Length 3 m (shielded wire)			BRCW901A03	
	Length 8 m (shielded wire)			BRCW901A08	
5-room centralised controller ²				KRC72	
Adaptor PCB (normal open/normal open pulse contact) ³				KRP413A1S	
The remote controller loss prevention with the chain				KKF917A4	
Interface adaptor for DIIH-NET use				KRP928B2S	
Central remote controller ⁴				DCS302CA61	
Unified ON/OFF controller ⁴				DCS301BA61	
Schedule timer ⁴				DST301BA61	
Intelligent Touch Controller ⁴				DCS601CS1	
Suction grille				KDGF19A45	
Insulation kit for high humidity			KDT25N50		KDT25N63

Note: ¹3 m (BRCW901A03) or 8 m (BRCW901A08) length wired remote controller cord is necessary.
²Adaptor PCB is also required for each indoor unit.
³Time clock and other devices; obtained locally.
⁴This optional accessory requires KRP928B2S.

DUCT CONNECTION MIDDLE & HIGH STATIC PRESSURE TYPE



Name of option	Remark	Kit name					
		FBQ50DV1	FBQ60DV1	FBQ71DV1	FBQ100DV1	FBQ125DV1	FBQ140DV1
High-efficiency filter ¹	(Colorimetric method 65%)		KAF372AA80			KAF372AA160	
	(Colorimetric method 90%)		KAF373AA80			KAF373AA160	
Filter chamber			KDF37AA80			KDF37AA160	
Replacement long-life filter			KAF371AA80			KAF371AA160	
Replacement long-life filter chamber kit			KAF375AA80			KAF375AA160	
Service panel			KTBJ25KA80W			KTBJ25KA160W	
			KTBJ25K80F			KTBJ25K160F	
			KTBJ25K80T			KTBJ25K160T	
Air discharge adaptor			KDAJ25K71A			KDAJ25K140A	
Remote Controller	Wireless type					BRC4C64	
	Cooling Only					BRC4C62	
	Heat Pump					BRC1C61	
	Wired type ²					BRC1D61	
Wired LCD remote controller with weekly schedule timer ²						BRC1E62	
Navigation Remote Controller	Wired type ²					KRP1C64*	
Adaptor for wiring (interlock for fresh air intake fan)						KRP4AA51*	
Wiring adaptor for electrical appendices						KRCS01-4B	
Remote sensor						KRP4A96 ^{5,6}	
Mounting plate for adaptor PCB. ³						DCS302CA61	
Central remote controller ⁴						DCS301BA61	
Unified ON/OFF controller ⁴						DST301BA61	
Schedule timer ⁴						DCS601CS1	
Intelligent Touch Controller ⁴							

Note: ¹If installing a high efficiency filter on the unit, an assembly chamber for either bottom or rear suction is required.
²Wiring for wired remote controller to be procured locally.
³Mounting plate for adaptor PCB is necessary for each adaptor marked ★.
⁴This type of indoor units is equipped with the interface adaptor for SkyAir series, DTA112BA51 is unnecessary.
⁵Up to 2 adaptors can be fixed for each mounting plate.
⁶Only one mounting plate can be installed for each indoor unit.



JMI-0107

ORGANIZATION:
 DAIKIN INDUSTRIES, LTD.
 AIR CONDITIONING MANUFACTURING DIVISION

SCOPE OF REGISTRATION:
 THE DESIGN/DEVELOPMENT AND MANUFACTURE OF COMMERCIAL AIR CONDITIONING, HEATING, COOLING, REFRIGERATING EQUIPMENT, COMMERCIAL HEATING EQUIPMENT, RESIDENTIAL AIR CONDITIONING EQUIPMENT, HEAT RECLAIM VENTILATION, AIR CLEANING EQUIPMENT, MARINE TYPE CONTAINER REFRIGERATION UNITS, COMPRESSORS AND VALVES.



JQA-1452

ORGANIZATION:
 DAIKIN INDUSTRIES (THAILAND) LTD.

SCOPE OF REGISTRATION:
 THE DESIGN/DEVELOPMENT AND MANUFACTURE OF AIR CONDITIONERS AND THE COMPONENTS INCLUDING COMPRESSORS USED FOR THEM.



EC99J2044

ALL OF THE DAIKIN GROUP'S BUSINESS FACILITIES AND SUBSIDIARIES IN JAPAN ARE CERTIFIED UNDER THE ISO 14001 INTERNATIONAL STANDARD FOR ENVIRONMENTAL MANAGEMENT.

Warning

- Daikin products are manufactured for export to numerous countries throughout the world. Prior to purchase, please confirm with your local authorised importer, distributor and/or retailer whether this product conforms to the applicable standards, and is suitable for use, in the region where the product will be used. This statement does not purport to exclude, restrict or modify the application of any local legislation.
- Ask a qualified installer or contractor to install this product. Do not try to install the product yourself. Improper installation can result in water or refrigerant leakage, electrical shock, fire or explosion.
- Use only those parts and accessories supplied or specified by Daikin. Ask a qualified installer or contractor to install those parts and accessories. Use of unauthorised parts and accessories or improper installation of parts and accessories can result in water or refrigerant leakage, electrical shock, fire or explosion.
- Read the Users' Manual carefully before using the product. The User's Manual provides important safety instructions and warnings. Be sure to follow these instructions and warnings.

If you have any enquiries, please contact your local importer, distributor and/or retailer.

Cautions on product corrosion

- Air conditioners should not be installed in areas where corrosive gases, such as acid gas or alkaline gas, are produced.
- If the outdoor unit is to be installed close to the sea shore, direct exposure to the sea breeze should be avoided. If you need to install the outdoor unit close to the sea shore, contact your local distributor.